

---

*Comfort-Aire*®

Century®

---

**REMOTE  
CONTROLLER  
OWNER MANUAL**

**ZHP Series**

---

517-787-2100

# Table of Contents

<b>Remote Controller Specifications .....</b>	<b>02</b>
<b>Handling the Remote Controller .....</b>	<b>03</b>
<b>Buttons and Functions .....</b>	<b>04</b>
<b>Remote Screen Indicators .....</b>	<b>07</b>
<b>How to Use Basic Functions .....</b>	<b>08</b>
<b>How to Use Advanced Functions .....</b>	<b>10</b>

## Remote Controller Specifications

<b>Model</b>	RG10R(M2S)/BGEFU1, RG10R(E2S)/BGEFU1, RG10R(F2S)/BGEFU1
<b>Rated Voltage</b>	3.0V( Dry batteries R03/LR03×2)
<b>Signal Receiving Range</b>	8m
<b>Environment</b>	23~140°F(-5 ~ 60°C)

### Quick Start Guide

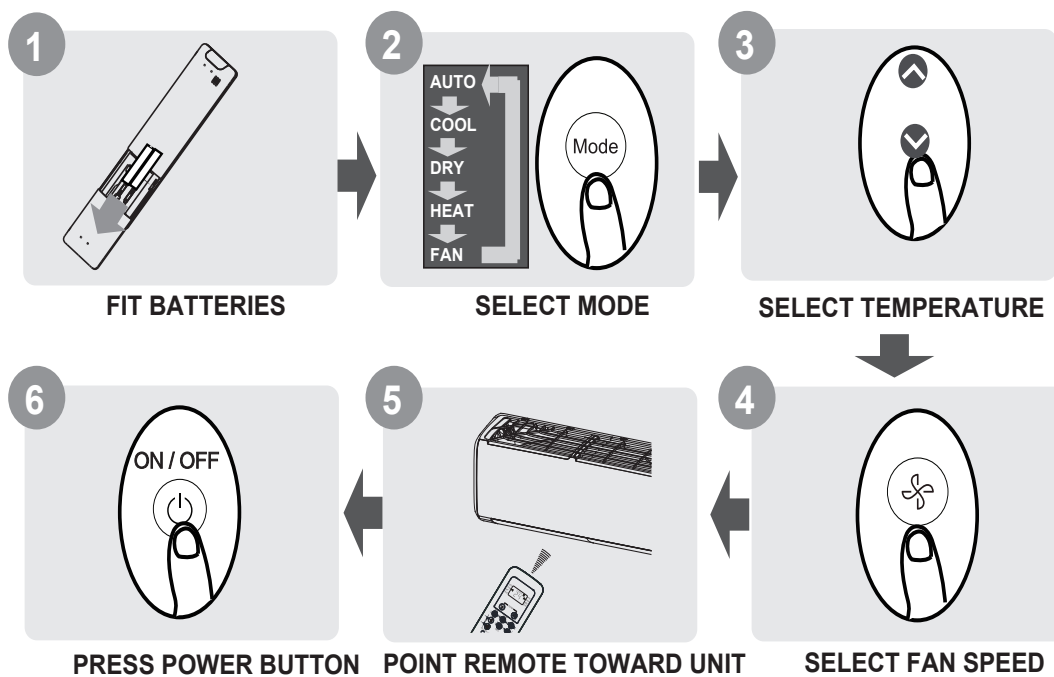

### NOT SURE WHAT A FUNCTION DOES?

Refer to the **How to Use Basic Functions** and **How to Use Advanced Functions** sections of this manual for a detailed description of how to use your air conditioner.

### SPECIAL NOTE

- Button designs on your unit may differ slightly from the example shown.
- If the indoor unit does not have a particular function, pressing that function's button on the remote control will have no effect.
- When there are wide differences between "Remote controller Manual" and "Owner's Manual" on function description, the description of "Owner's Manual" shall prevail.

# Handling the Remote Controller

## Inserting and Replacing Batteries

Your air conditioning unit may come with two batteries (some units). Put the batteries in the remote control before use.

1. Slide the back cover from the remote control downward, exposing the battery compartment.
2. Insert the batteries, paying attention to match up the (+) and (-) ends of the batteries with the symbols inside the battery compartment.
3. Slide the battery cover back into place.

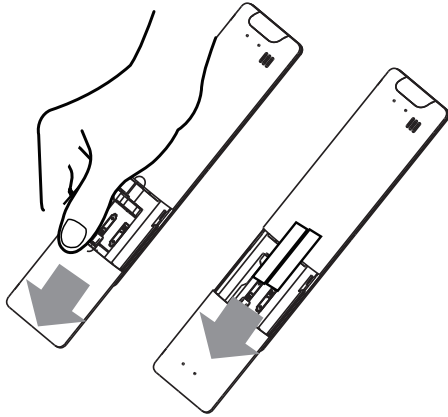

## ! BATTERY NOTES

For optimum product performance:

- Do not mix old and new batteries, or batteries of different types.
- Do not leave batteries in the remote control if you don't plan on using the device for more than 2 months.



## BATTERY DISPOSAL

Do not dispose of batteries as unsorted municipal waste. Refer to local laws for proper disposal of batteries.

## TIPS FOR USING REMOTE CONTROL

- The remote control must be used within 8 meters of the unit.
- The unit will beep when remote signal is received.
- Curtains, other materials and direct sunlight can interfere with the infrared signal receiver.
- Remove batteries if the remote will not be used more than 2 months.

## NOTES FOR USING REMOTE CONTROL

The device could comply with the local national regulations.

- In Canada, it should comply with CAN ICES-3(B)/NMB-3(B).
- In USA, this device complies with part 15 of the FCC Rules. Operation is subject to the following two conditions:
  - (1) This device may not cause harmful interference, and
  - (2) this device must accept any interference received, including interference that may cause undesired operation.

This equipment has been tested and found to comply with the limits for a Class B digital device, pursuant to part 15 of the FCC Rules. These limits are designed to provide reasonable protection against harmful interference in a residential installation. This equipment generates, uses and can radiate radio frequency energy and, if not installed and used in accordance with the instructions, may cause harmful interference to radio communications. However, there is no guarantee that interference will not occur in a particular installation. If this equipment does cause harmful interference to radio or television reception, which can be determined by turning the equipment off and on, the user is encouraged to try to correct the interference by one or more of the following measures:

- Reorient or relocate the receiving antenna.
- Increase the separation between the equipment and receiver.
- Connect the equipment into an outlet on a circuit different from that to which the receiver is connected.
- Consult the dealer or an experienced radio/TV technician for help.
- Changes or modifications not approved by the party responsible for compliance could void user's authority to operate the equipment.

## Buttons and Functions

Before you begin using your new air conditioner, make sure to familiarize yourself with its remote control. The following is a brief introduction to the remote control itself. For instructions on how to operate your air conditioner, refer to the **How to Use Basic Functions** section of this manual.

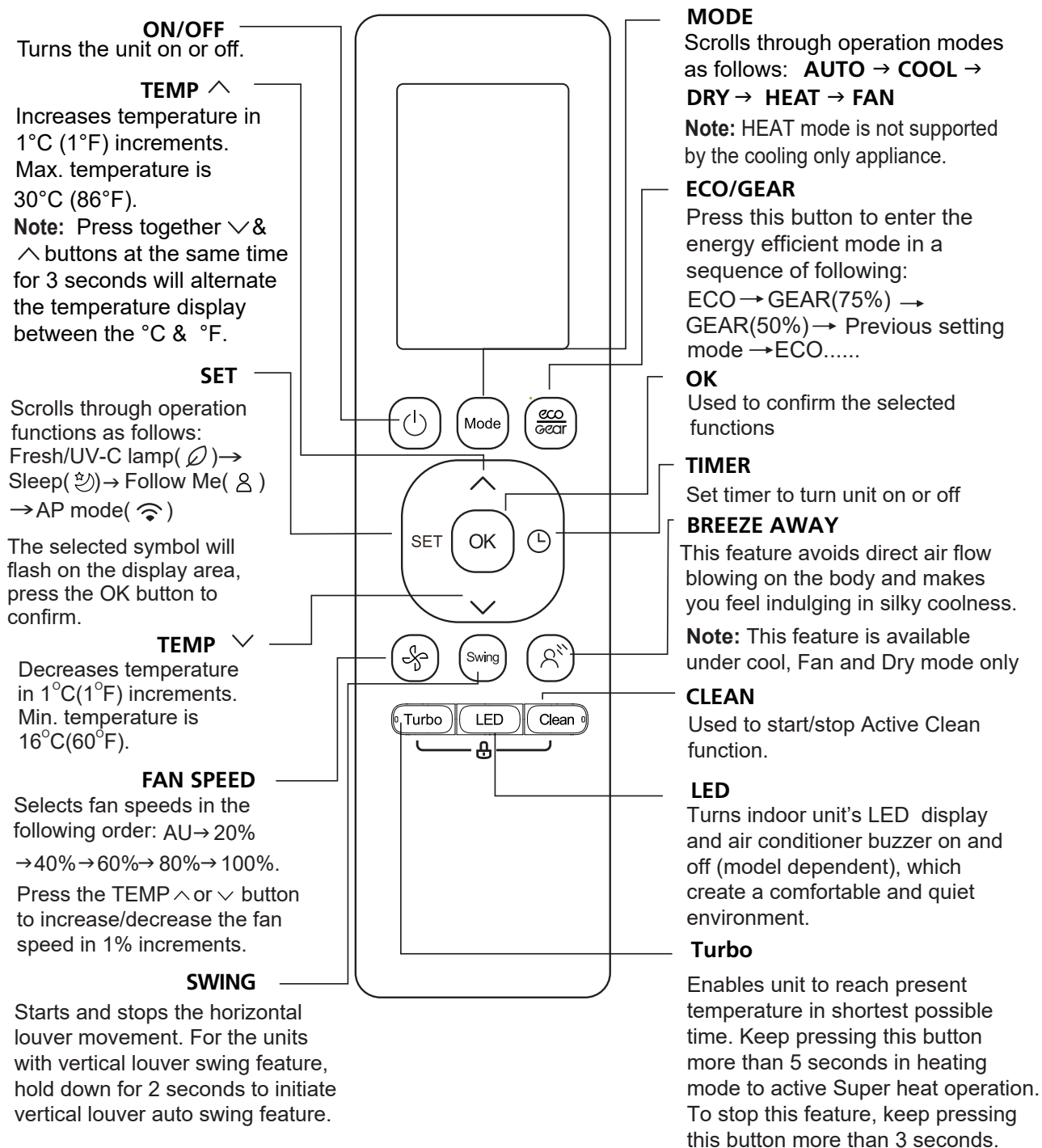

**Model:** RG10R(M2S)/BGEFU1

**ON/OFF**  
Turns the unit on or off.

**TEMP ^**  
Increases temperature in 1°C (1°F) increments. Max. temperature is 30°C (86°F).  
**Note:** Press together ∨ & ^ buttons at the same time for 3 seconds will alternate the temperature display between the °C & °F.

**SET**  
Scrolls through operation functions as follows:  
Fresh/UV-C lamp (☼) → Sleep (☺) → Follow Me (♫) → AP mode (📶) → Fresh.....  
The selected symbol will flash on the display area, press the OK button to confirm.

**TEMP ∨**  
Decreases temperature in 1°C (1°F) increments. Min. temperature is 16°C (60°F).

**FAN SPEED**  
Selects fan speeds in the following order: AU → 20% → 40% → 60% → 80% → 100%.  
Press the TEMP ^ or ∨ button to increase/decrease the fan speed in 1% increments.

**SWING**  
Starts and stops the horizontal louver movement. For the units with vertical louver swing feature, hold down for 2 seconds to initiate vertical louver auto swing feature.

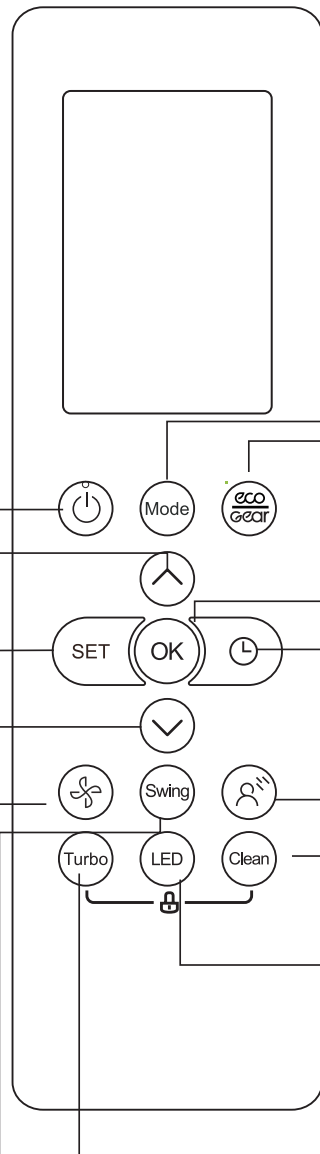

**MODE**  
Scrolls through operation modes as follows: **AUTO** → **COOL** → **DRY** → **HEAT** → **FAN**

**Note:** HEAT mode is not supported by the cooling only appliance.

**ECO/GEAR**  
Press this button to enter the energy efficient mode in a sequence of following:  
ECO → GEAR(75%) → GEAR(50%) → Previous setting mode → ECO.....

**OK**  
Used to confirm the selected functions

**TIMER**  
Set timer to turn unit on or off

**BREEZE AWAY**  
This feature avoids direct air flow blowing on the body and makes you feel indulging in silky coolness.

**Note:** This feature is available under cool, Fan and Dry mode only

**CLEAN**  
Used to start/stop Active Clean function.

**LED**  
Turns indoor unit's LED display and air conditioner buzzer on and off (model dependent), which create a comfortable and quiet environment.

**Turbo**  
Enables unit to reach present temperature in shortest possible time. Keep pressing this button more than 5 seconds in heating mode to active Super heat operation. To stop this feature, keep pressing this button more than 3 seconds.

**Model:** RG10R(E2S)/BGEFU1

**ON/OFF**  
Turns the unit on or off.

**TEMP ^**  
Increases temperature in 1°C (1°F) increments. Max. temperature is 30°C (86°F).

**Note:** Press together ∇ & ^ buttons at the same time for 3 seconds will alternate the temperature display between the °C & °F.

**SET**  
Scrolls through operation functions as follows:  
Fresh/UV-C lamp (☼) → Sleep (🌙) → Follow Me (👤) → AP mode (📶)

The selected symbol will flash on the display area, press the OK button to confirm.

**TEMP ∇**  
Decreases temperature in 1°C(1°F) increments. Min. temperature is 16°C(60°F).

**FAN SPEED**  
Selects fan speeds in the following order: AU→ 20% →40%→60%→ 80%→ 100%.  
Press the TEMP ^ or ∇ button to increase/decrease the fan speed in 1% increments.

**SWING**  
Starts and stops the horizontal louver movement. For the units with vertical louver swing feature, hold down for 2 seconds to initiate vertical louver auto swing feature.

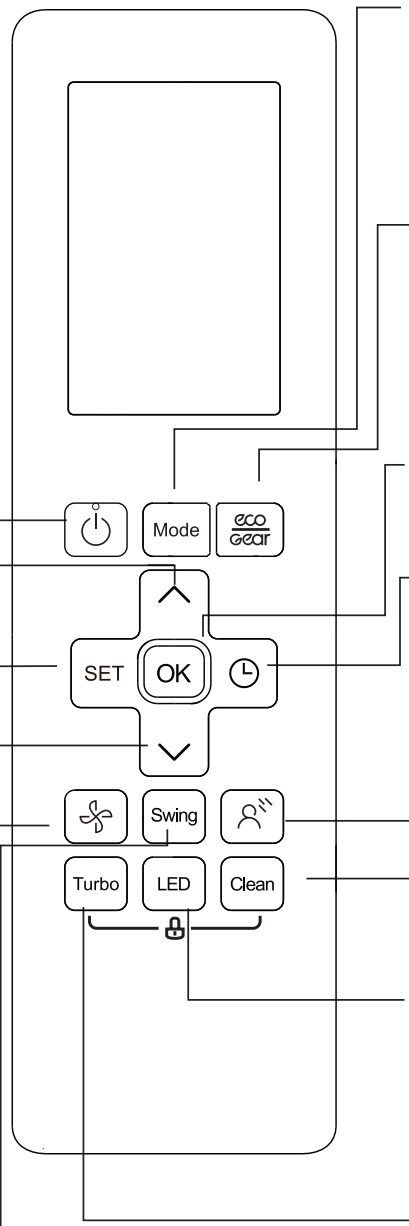

**MODE**  
Scrolls through operation modes as follows: **AUTO** → **COOL** → **DRY** → **HEAT** → **FAN**  
**Note:** HEAT mode is not supported by the cooling only appliance.

**ECO/GEAR**  
Press this button to enter the energy efficient mode in a sequence of following:  
ECO → GEAR(75%) → GEAR(50%) → Previous setting mode → ECO.....

**OK**  
Used to confirm the selected functions

**TIMER**  
Set timer to turn unit on or off

**BREEZE AWAY**  
This feature avoids direct air flow blowing on the body and makes you feel indulging in silky coolness.

**Note:** This feature is available under cool, Fan and Dry mode only

**CLEAN**  
Used to start/stop Active Clean function.

**LED**  
Turns indoor unit's LED display and air conditioner buzzer on and off (model dependent), which create a comfortable and quiet environment.

**TURBO**  
Enables unit to reach present temperature in shortest possible time. Keep pressing this button more than 5 seconds in heating mode to active Super heat operation. To stop this feature, keep pressing this button more than 3 seconds.

**Model:** RG10R(F2S)/BGEFU1

# Remote Screen Indicators

Information are displayed when the remote controller is power up.

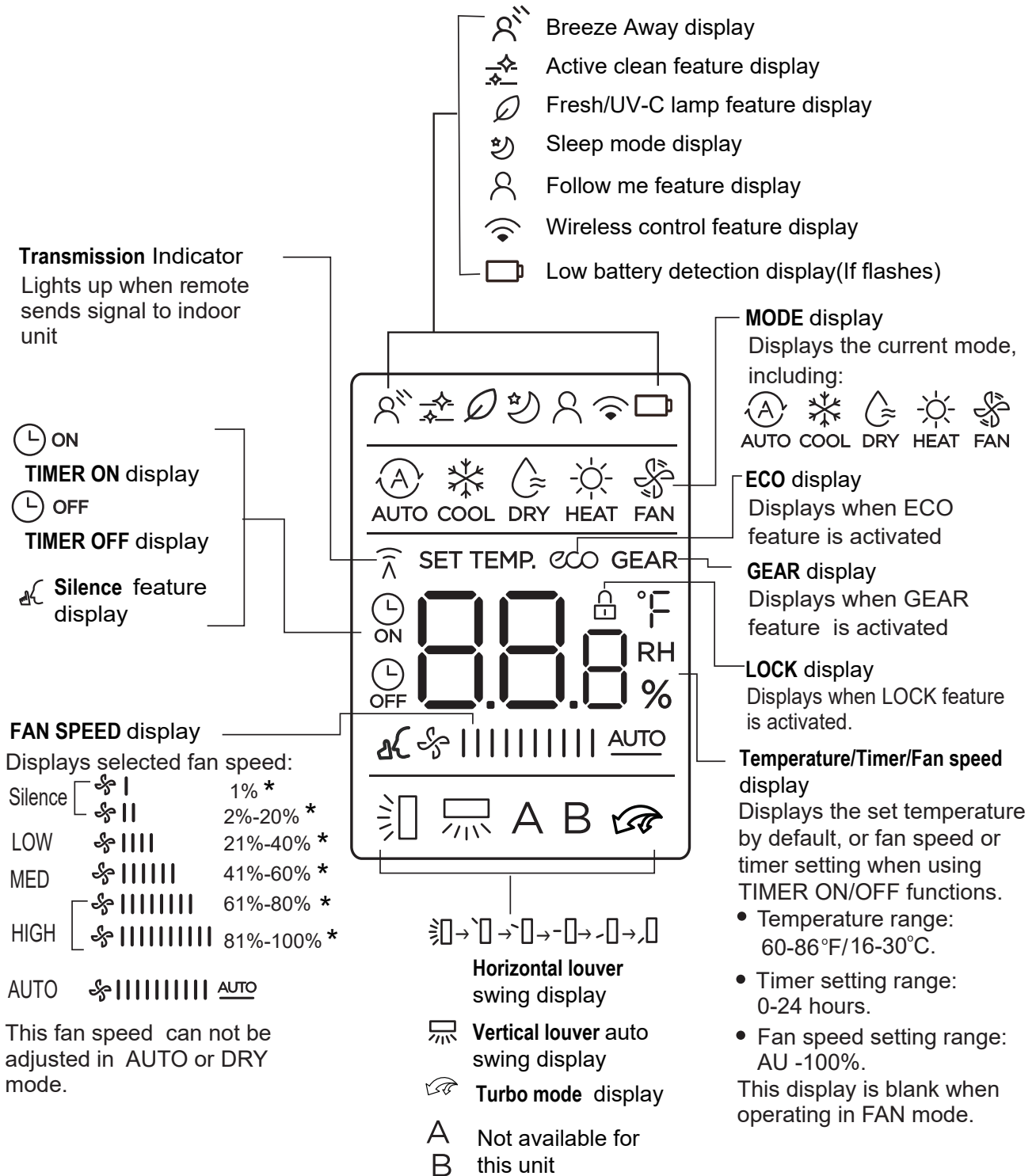

**Note:**

All indicators shown in the figure are for the purpose of clear presentation. But during the actual operation, only the relative function signs are shown on the display window.

# How to Use Basic Functions

**! ATTENTION** Before operation, please ensure the unit is plugged in and power is available.

## AUTO Mode

Select AUTO mode



Set your desired temperature



Turn on the air conditioner



### NOTE:

1. In AUTO mode, the unit will automatically select the COOL, FAN, or HEAT function based on the set temperature.
2. In AUTO mode, fan speed can not be set.

## COOL or HEAT Mode

Select COOL/HEAT mode

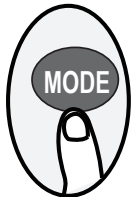

Set the temperature



Set the fan speed



Turn on the air conditioner



## DRY Mode

Select DRY mode

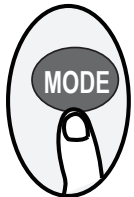

Set your desired temperature



Turn on the air conditioner



**NOTE:** In DRY mode, fan speed can not be set since it has already been automatically controlled.

## FAN Mode

Select FAN mode

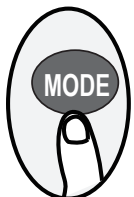

Set the fan speed



Turn on the air conditioner



**NOTE:** In FAN mode, you can't set the temperature. As a result, no temperature displays in remote screen.

## Setting the TIMER

**TIMER ON/OFF** - Set the amount of time after which the unit will automatically turn on/off.

### TIMER ON setting

Press TIMER button to initiate the ON time sequence.



Press Temp. up or down button for multiple times to set the desired time to turn on the unit.

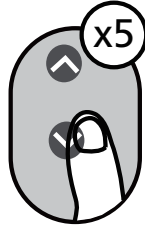

Point remote to unit and wait 1sec, the TIMER ON will be activated.



### TIMER OFF setting

Press TIMER button to initiate the OFF time sequence.

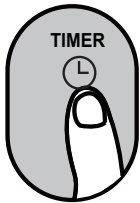

Press Temp. up or down button for multiple times to set the desired time to turn off the unit.

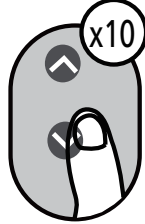

Point remote to unit and wait 1sec, the TIMER OFF will be activated.



#### NOTE:

1. When setting the TIMER ON or TIMER OFF, the time will increase by 30 minutes increments with each press, up to 10 hours. After 10 hours and up to 24, it will increase in 1 hour increments. (For example, press 5 times to get 2.5h, and press 10 times to get 5h,) The timer will revert to 0.0 after 24.
2. Cancel either function by setting its timer to 0.0h.

### TIMER ON & OFF setting(example)

Keep in mind that the time periods you set for both functions refer to hours after the current time.

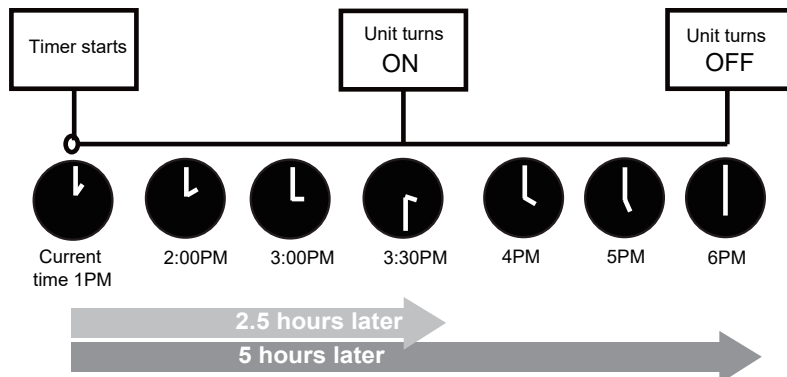
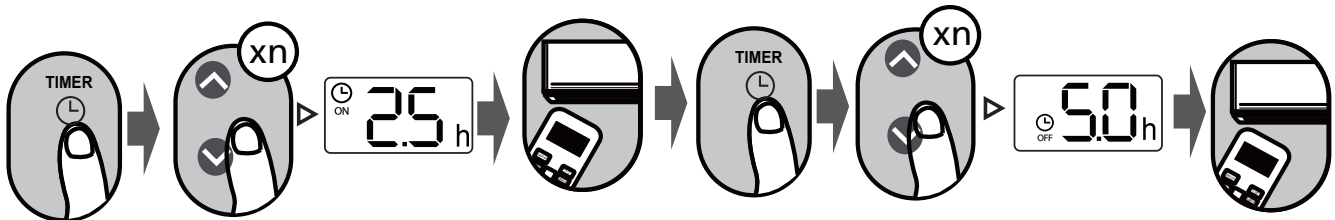

Example: If current time is 1:00PM, to set the timer as above steps, the unit will turn on 2.5h later (3:30PM) and turn off at 6:00PM.

# How to Use Advanced Functions

## Swing function

Press Swing button

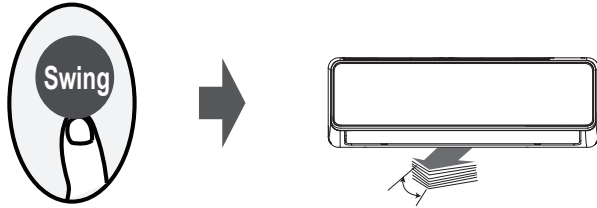

The horizontal louver will swing up and down automatically when pressing Swing button. Press again to make it stop.

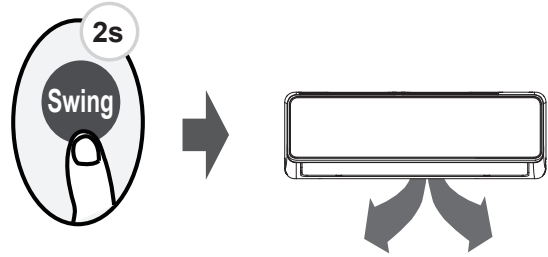

Keep pressing this button more than 2 seconds, the vertical louver swing function is activated. (For the units with vertical louver swing feature)

## Airflow direction

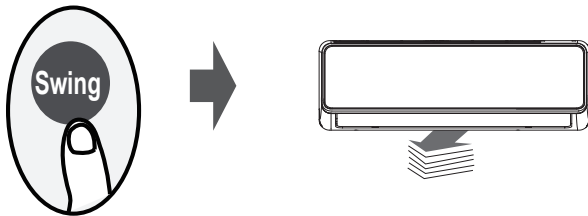

If continue to press the SWING button, five different airflow directions can be set. The louver can be move at a certain range each time you press the button. Press the button until the direction you prefer is reached.

## LED DISPLAY

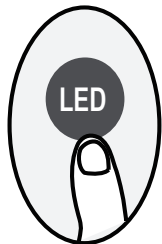

Press LED button

Press this button to turn on and turn off the display on the indoor unit.

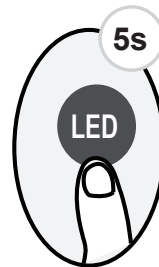

Press this button more than 5 seconds(some units)

Keep pressing this button more than 5 seconds, the indoor unit will display the actual room temperature. Press more than 5 seconds again will revert back to display the setting temperature.

## LOCK function

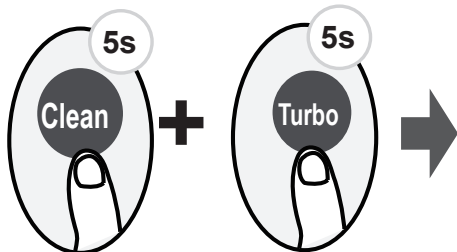

Press together **Clean** button and **Turbo** button at the same time more than 5 seconds to activate Lock function. All buttons will not response except pressing these two buttons for two seconds again to disable locking.

## ECO/GEAR function



Press this button to enter the energy efficient mode in a sequence of following:  
ECO → GEAR(75%) → GEAR(50%) → Previous setting mode → ECO....

Note: This function is only available under COOL mode.

## ECO operation:

Under cooling mode, press this button, the remote controller will adjust the temperature automatically to 24°C/75°F, fan speed of Auto to save energy (only when the set temperature is less than 24°C/75°F). If the set temperature is above 24°C/75°F, press the ECO button, the fan speed will change to Auto, the set temperature will remain unchanged.

### NOTE:

Pressing the ECO/GEAR button, or modifying the mode or adjusting the set temperature to less than 24°C/75°F will stop ECO operation.

Under ECO operation, the set temperature should be 24°C/75°F or above, it may result in insufficient cooling. If you feel uncomfortable, just press the ECO button again to stop it.

## GEAR operation:

Press the ECO/GEAR button to enter the GEAR operation as following:  
75%(up to 75% electrical energy consumption) → 50%(up to 50% electrical energy consumption) → Previous setting mode.

Under GEAR operation, the setting temperature will revert back in the display screen after 3 seconds you select the desired electrical energy consumption operation.

## Silence function

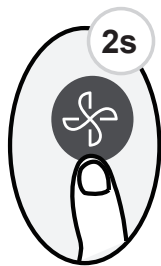

Keep pressing Fan button for more than 2 seconds to activate/disable Silence function.

Due to low frequency operation of compressor, it may result in insufficient cooling and heating capacity. Press ON/OFF, Mode, Turbo or Clean button or start sleep feature while operating will cancel silence function.

## FP function

Press this button 2 times during one second under HEAT Mode and setting temperature of 16°C/60°F .



The unit will operate at high fan speed (while compressor on) with temperature automatically set to 8°C/46°F.

**Note:** This function is for heat pump air conditioner only.

Press this button 2 times under HEAT Mode and setting temperature of 16°C/60°F to activate the FP function. Press On/Off, Mode, Fan and Temp. button or start sleep feature while operating will cancel this function.

## CLEAN function

Press Clean button to active active clean function.



The Active Clean Technology washes away dust, mold, and grease that may cause odors when it adheres to the heat exchanger by automatically freezing and then rapidly thawing the frost. When this function is turned on, the indoor unit display window appears "CL", after 20 to 45 minutes, the unit will turn off automatically and cancel CLEAN function.

## Turbo Function

Press Turbo button



When you select Turbo feature in COOL mode, the unit will blow cool air with strongest wind setting to jump-start the cooling process.

When you select Turbo feature in HEAT mode, the unit will blow heat air with strongest wind setting to jump-start the heating process.

For units with Electric heat elements, the Electric HEATER will activate and jump-start the heating process.

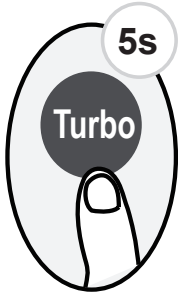

### Super heat function

Long press Turbo button for 5 seconds in Heating/Auto heating mode to initiate super heat function. To stop this feature, long press this button for 3 seconds. This function is mainly used to improve the heating speed of the unit at low temperature.

Under super heat mode, the louver will open to its maximum angle to enable unit to reach preset temperature in shortest possible time.

Note: The anti-cold air feature is disabled 5 minutes later after the compressor starts, it may result in low air outlet temperature. You should choose whether to enable this function according to your need.

### NOTE:

- If the Super heat function is activated, “ **On** ” displays for 3 seconds on the indoor unit display window.
- If the Super heat function is stopped, “ **OF** ” displays for 3 seconds on the indoor unit display window.
- Change the mode or turn the unit off to stop the super heating operation.

## SET function

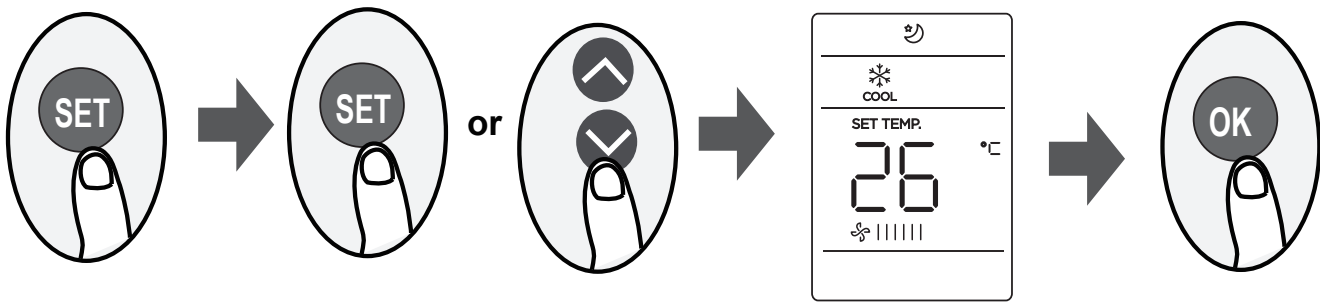

- Press the SET button to enter the function setting, then press SET button or TEMP  $\nabla$  or TEMP  $\blacktriangle$  button to select the desired function. The selected symbol will flash on the display area, press the OK button to confirm.
- To cancel the selected function, just perform the same procedures as above.
- Press the SET button to scroll through operation functions as follows:  
Fresh/UV-C lamp\* (  $\text{leaf}$  )  $\rightarrow$  Sleep (  $\text{moon}$  )  $\rightarrow$  Follow Me (  $\text{person}$  )  $\rightarrow$  AP mode (  $\text{wifi}$  )  
[\*]: Only for the unit has Fresh or AP function.

### FRESH/UV-C lamp function:

When this function is selected, the Ionizer or UV-C lamp(model dependent) will be activated. If has both features, these two features will be activated at the same time. This function will help to purify the air in the room.

### Sleep function:

The SLEEP function is used to decrease energy use while you sleep (and don't need the same temperature settings to stay comfortable). This function can only be activated via remote control.

For the detail, see "sleep operation" in "Owner's Manual".

**Note:** The SLEEP function is not available in FAN or DRY mode.

### AP function:

Choose AP mode to do wireless network configuration. If it doesn't work by pressing the SET button. To enter the AP mode, continuously press the LED button seven times in 10 seconds.

### Follow me function:

The FOLLOW ME function enables the remote control to measure the temperature at its current location and send this signal to the air conditioner every 3 minutes interval. When using AUTO, COOL or HEAT modes, measuring ambient temperature from the remote control(instead of from the indoor unit itself) will enable the air conditioner to optimize the temperature around you and ensure maximum comfort.

#### Note:

Press the SET button to select Follow Me function, then press OK button to confirm. Pressing the OK button for 3 seconds will start/stop memory feature of Follow Me function.

- If the memory feature is activated, " **On** " displays for 3 seconds on the screen.
- If the memory feature is stopped, " **OF** " displays for 3 seconds on the screen.
- While the memory feature is activated, press the ON/OFF button, shift the mode or power failure will not cancel the Follow me function.

---

Due to ongoing product improvements, specifications and dimensions are subject to change and correction without notice or incurring obligations. Determining the application and suitability for use of any product is the responsibility of the installer. Additionally, the installer is responsible for verifying dimensional data on the actual product prior to beginning any installation preparations.

Incentive and rebate programs have precise requirements as to product performance and certification. All products meet applicable regulations in effect on date of manufacture; however, certifications are not necessarily granted for the life of a product. Therefore, it is the responsibility of the applicant to determine whether a specific model qualifies for these incentive/rebate programs.



1900 Wellworth Ave., Jackson, MI 49203 • Ph. 517-787-2100 • [www.heatcontroller.com](http://www.heatcontroller.com)