

*Comfort-Cire*®

**Century**®

**WIRED CONTROLLER  
INSTALLATION AND OWNER'S  
MANUAL**

**Model**

**KJR-120G1/TFBG-E-01**

**KJR-120G2/TFBG-E-03**



- This manual gives detailed description of the precautions that should be brought to your attention during operation.
- To ensure the correct service of the wired controller, read this manual carefully before using the unit.
- Keep this manual after reading for future reference.

# CONTENTS

1. SAFETY PRECAUTION.....	1
2. INSTALLATION ACCESSORY.....	2
3. INSTALLATION METHOD.....	4
4. APPENDIX INSTALL THE WIRE CONTROLLER KIT.....	15
5. SPECIFICATION.....	21
6. WIRED CONTROLLER FEATURES AND FUNCTIONS.....	22
7. WIRED CONTROLLER DISPLAY.....	23
8. WIRED CONTROLLER BUTTONS.....	24
9. PREPARATORY OPERATION.....	25
10. OPERATION.....	26
11. TIMER FUNCTIONS.....	32
12. WEEKLY TIMER.....	35
13. SET EXTERNAL STATIC PRESSURE.....	42
14. FAULT ALARM HANDING.....	43
15. TECHNICAL INDICATION AND REQUIREMENT .....	43

# 1. SAFETY PRECAUTION

- Read the safety precautions carefully before installing the unit.
- Stated below are important safety issues that must be obeyed.

 WARNING	Means improper handling may lead to personal death or severe injury.
 CAUTION	Means improper handling may lead to personal injury or property loss.



## WARNING

Please entrust the distributor or professionals to install the unit.  
Installation by other persons may lead to imperfect installation, electric shock or fire.  
Adhere to this installation manual.  
Improper installation may lead to electric shock or fire.  
Reinstallation must be performed by professionals.

Do not uninstall the unit randomly.  
Random uninstalling may lead to abnormal operation, heating or fire of the air condition.



## NOTE

- ① Do not install the unit in a place vulnerable to leakage of flammable gases. Once flammable gases are leaked and left around the wire controller, fire may occur.
- ② Do not operate with wet hands or let water enter the wire controller. Otherwise, electric shock may occur.
- ③ The wiring should adapt to the wire controller current. Otherwise, electric leakage or heating may occur and result in fire.
- ④ The specified cables shall be applied in the wiring. No external force may be applied to the terminal. Otherwise, wire cut and heating may occur and result in fire.

## 2. INSTALLATION ACCESSORY

### Select the installation location

Don't install at the place where cover with heavy oil, vapor or sulfured gas, otherwise, this product would be deformed that would lead to system malfunction.

### Preparation before installation

1. Please confirm that all the following parts you have been supply.

No.	Name	Qty.	Remarks
1	Wire controller	1	_____
2	Installation and owner's manual	1	_____
3	Screws	3	ST3.9X25 (For Mounting on the Wall)
4	Wall plugs	3	For Mounting on the Wall
5	Screws	2	M4X25 (For Mounting on switch box)
6	Plastic screw bars	2	For fixing on switch box
7	Battery	1	
8	The connection cable	1	(Optional)

2. Prepare the following assemblies on the site.

No.	Name	Qty.(embedded into wall)	Specification (only for reference)	Remarks
1	Switch box	1	_____	_____
2	Wiring Tube(Insulating Sleeve and Tightening Screw)	1	_____	_____

## 2. INSTALLATION ACCESSORY

---

### WIRED CONTROLLER INSTALLATION PRECAUTION

1. This manual provides the wired controller installation method. Refer to the wiring diagram in this installation manual to wire the wired controller with the indoor unit.
2. The wired controller works in a low voltage loop circuit. Do not connect directly to 208/230V and 460V. Do not wire this kind of wire into a loop. Wiring clearance between the configured tubes should range 11.81–19.69 inches (30–50 cm) or above.
3. The shielded wire of the wired controller must be properly grounded.
4. Upon finish the wire controller connection, do not employed tramegger to detect the insulation.

### 3. INSTALLATION METHOD

#### 1. Wired Remote Controller Dimensions

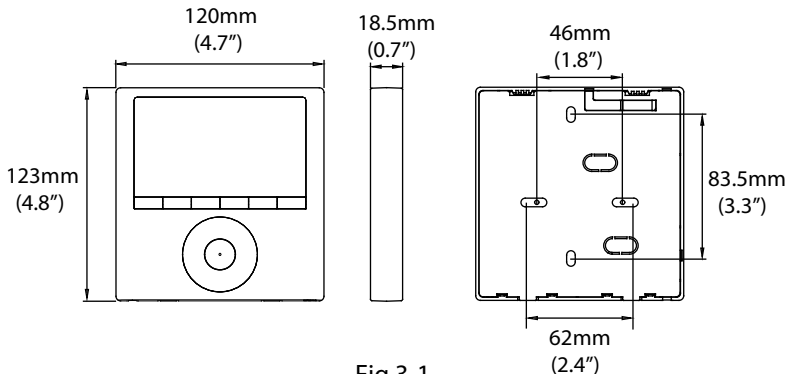
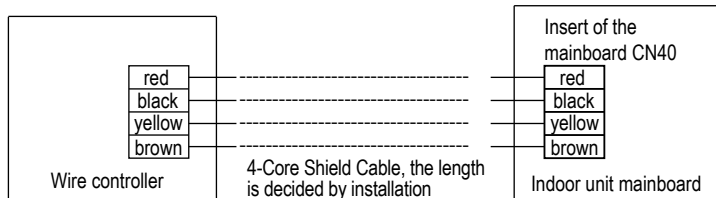

Fig 3-1

#### 2. Wiring Connection Diagram



### 3. INSTALLATION METHOD

#### 3.Wiring figure

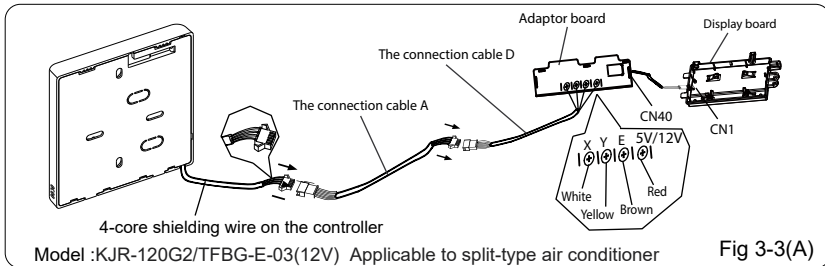
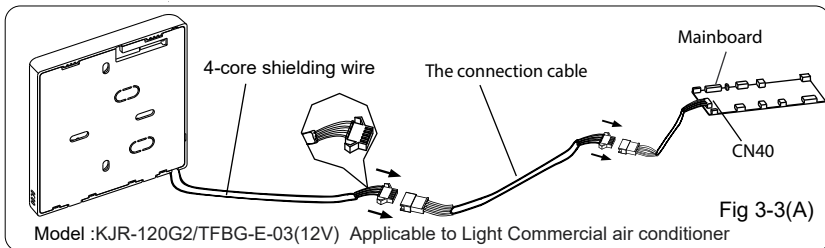

- Connect the female joint of the wires group from the mainboard with the male joint of the connective wires group. (See Fig.3-3(A))
- Connect the other side of the connective wires group with the male joint of the wires group leads from the wire controller.(See Fig.3-3(A))

### 3. INSTALLATION METHOD

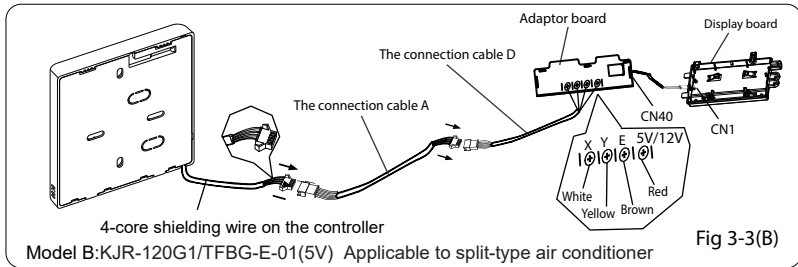
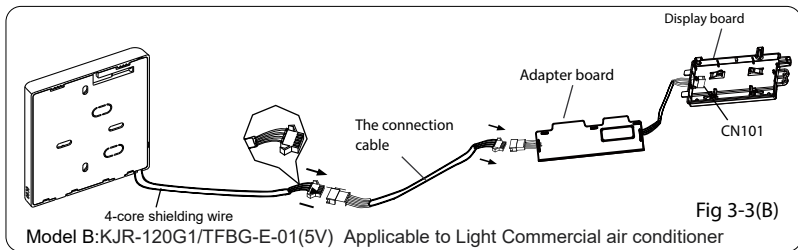

- Install the Adapter Board and the Display Board on the High Wall (See the Appendix for instructions).
- Connect the female joint of the wires group from the adapter board with the male joint of the connective wires group. Next, connect the other side of the adapter board with the display board. (See Fig-3-3(B))
- Connect the other side of the connective wires group with the male joint of the wires group leads from the wire controller. (See Fig-3-3(B))

### 3. INSTALLATION METHOD

---

#### 4. Wire controller upper part Remove

- Insert a flat screwdriver into the slots in the lower part of the wire controller (2 places).
- Remove the upper part of the wire controller (Fig.3-4)

NOTE: The PCB is mounted in the upper part of the wired controller. Be careful not to damage the board with the screwdriver.

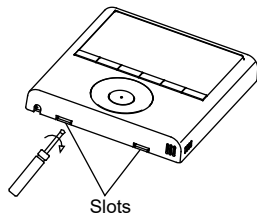

Fig 3-4

#### 5. Fasten the wire controller back plate

- For surface mounting, fasten the back plate on the wall with the 3 screws (ST3.9x25) and plugs. (Fig.3-5)

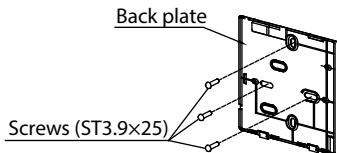

Fig 3-5

### 3. Installation method



#### BATTERY WARNING



**WARNING:** Contains coin battery.

#### **⚠ WARNING**

**INGESTION HAZARD:** This product contains a button cell or coin battery.

- **BATTERY WARNING: KEEP OUT OF REACH OF CHILDREN;**
- If the battery compartment (if applicable) does not close securely, stop using the product and keep it away from children;
- If you think batteries might have been swallowed or placed inside any part of the body, seek immediate medical attention.

### 3. Installation method



#### BATTERY WARNING

#### KEEP OUT OF REACH OF CHILDREN.

Swallowing can lead to chemical burns, perforation of soft tissue, and death. Severe burns can occur within 2 hours of ingestion. Seek medical attention immediately.



#### WARNING

- **INGESTION HAZARD:** This product contains a button cell or coin battery.
- **DEATH** or serious injury can occur if ingested.
- A swallowed button cell or coin battery can cause **Internal Chemical Burns** in as little as **2 hours**.
- **KEEP** new and used batteries **OUT OF REACH** of **CHILDREN**.
- **Seek immediate medical attention if a battery** is suspected to be swallowed or inserted inside any part of the body.



### 3. Installation method



#### **WARNING**

- Remove and immediately recycle or dispose of used batteries according to local regulations and keep away from children. Do NOT dispose of batteries in household trash or incinerate.
- Even used batteries may cause severe injury or death.
- Call a local poison control center for treatment information.
- Non-rechargeable batteries are not to be recharged.
- Do not force discharge, recharge, disassemble, heat above (-20-70°C) or incinerate. Doing so may result in injury due to venting, leakage or explosion resulting in chemical burns.
- Ensure the batteries are installed correctly according to polarity (+ and -).
- Do not mix old and new batteries, different brands or types of batteries, such as alkaline, carbon-zinc, or rechargeable batteries.
- Remove and immediately recycle or dispose of batteries from equipment not used for an extended period of time according to local regulations.

### 3. Installation method

- Always completely secure the battery compartment. If the battery compartment does not close securely, stop using the product, remove the batteries, and keep them away from children.
- Battery type: CR2032
- Battery power supply: 3.0V

### 3. INSTALLATION METHOD

- For switch box mounting, fasten the back plate on the switch box with 2 screws (M4x25) and fasten it on the wall with 1 screw (ST3.9x25). (Fig.3-6)

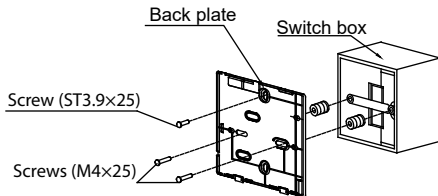

Fig 3-6

NOTE: Place on a flat surface. Be careful not to distort the wire controller's back plate by over-tightening the mounting screws.

### 6. Battery installation

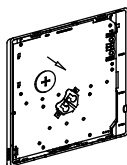

Fig 3-7

- Place the battery in the unit and ensure the positive side of the battery is in accordance with the polarity markings.(See Fig.3-7)
- Set the correct time before operating. Batteries in the wired controller can maintain the correct time during a power failure. When the power is restored and the displayed time is not correct, replace the battery.

### 3. INSTALLATION METHOD

#### 7. Wire the indoor unit

There are three methods:

- 1 from the rear;
- 2 from the bottom;
- 3 from the top;

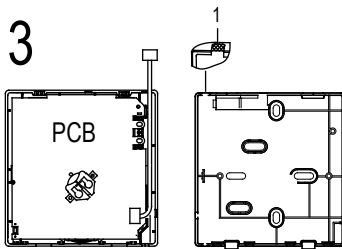
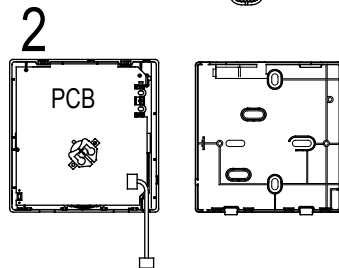
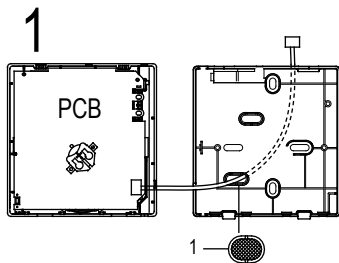

4. Notch the part for the wiring to pass through with a nipper tool.

### 3. INSTALLATION METHOD

**NOTE: DO NOT** allow water to enter the remote control.  
Use the trap and putty to seal the wires.

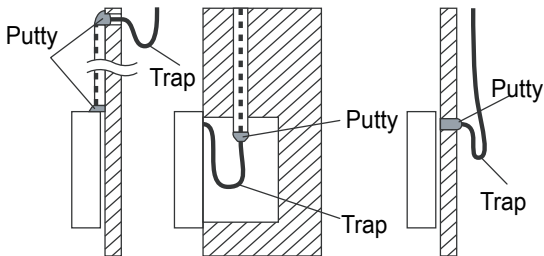

Fig 3-8

#### 8. Reattach the wire controller's upper part

- While adjusting and mounting the upper case, avoid clamping the wiring during installation. (Fig 3-9)

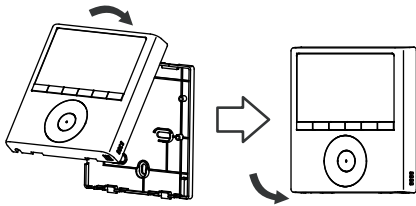

Fig 3-9

**IMPORTANT:** All the pictures in this manual are for illustration purposes only. Your wire controller may differ slightly.

## 4. APPENDIX

### INSTALL THE WIRE CONTROLLER KIT

---

1. Open the front panel.



2. Disconnect the wire from the main controller board.



## 4. APPENDIX

### INSTALL THE WIRE CONTROLLER KIT

---

3. Identify the components. From left to right, the wired controller, convert board and the display board.



4. Identify connections on the Display Board.

- CN201 is the display board connection to the main board wire (on the display board).



## 4. APPENDIX

### INSTALL THE WIRE CONTROLLER KIT

---

- CN101 is the display board connection to the convert board wire (on the display board).



5. Uninstall the display board from the front panel. Keep the display board holder.



## 4. APPENDIX

### INSTALL THE WIRE CONTROLLER KIT

---

6. Carefully bend and break off the rectangular section (upper left section with two diagonal holes) from the display board.



NOTE: Break off the upper left hand rectangle (section with the two holes marked with a red rectangle).

7. Replace the old display board (for the New Display board provided) and secure with the clips. To uninstall the clips, push the clips inward.
- NOTE:** There are 4 clips just above the numeric display (88) which run the length of the holder.



## 4. APPENDIX

### INSTALL THE WIRE CONTROLLER KIT

---

8. Before assembling mounting back on the Front Panel, remove the display board's screen cover.



9. Connect the Wires to the Adaptor Board.  
a. Connect the wire coming from the Display board to the Convert Board (this connection consists of 5 wires).



## 4. APPENDIX

### INSTALL THE WIRE CONTROLLER KIT

---

- b. Connect the wire coming from the Wired Remote Controller to the Convert Board (this connection consists of 4 wires).



10. Once the ports are connected, install the cover.



11. Mount the new display board and convert board to the Front Panel.  
12. Connect the wired remote controller to the display board and the convert board.



13. Connect the wire from the main controller board (see Fig 3-2).

## 5. SPECIFICATION

---

Input voltage	DC 5V/DC 12V
Ambient temperature	23~110°F (-5~43°C)
Ambient humidity	RH40%~RH90%

### Wiring specifications

Wiring type	Size	Total length
Shielded vinyl cord or cable	0.029 in-0.74mm (0.75-1.25mm <sup>2</sup> )	≤66 ft (20m)
		≤164 ft (50m)

## 6. FEATURE AND FUNCTION OF THE WIRED CONTROLLER

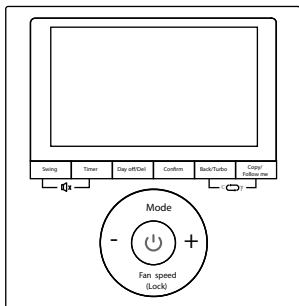

MODEL: KJR-120G2/TFBG-E-03(12V)

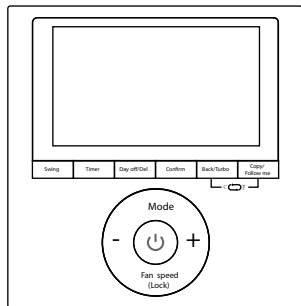

MODEL: KJR-120G1/TFBG-E-01(5V)

### Feature:

- LCD display.
- Malfunction code display: displays the error code (helpful for servicing)
- 4-way wire layout design.
- Room temperature display.
- Weekly Timer

### Function:

- Mode: choose Auto-Cool-Dry-Heat-Fan
- Fan speed: Auto-Low-Med-High
- Swing(on some models)
- Timer ON/OFF
- Temp setting
- Weekly Timer
- Follow me
- Child Lock
- LCD Display
- Clock
- Faceplate function (on some models)

## 7. WIRED CONTROLLER DISPLAY

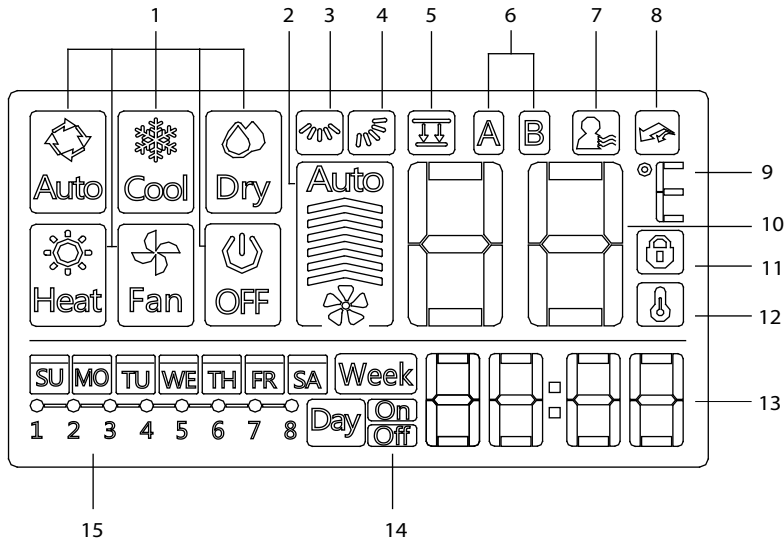

- |   |  |
|---|--|
| 1. Operation mode indicator               | 8. Turbo/Auxiliary Heat function indicator |
| 2. Fan speed indicator                    | 9. °C / °F indicator                       |
| 3. Left-right swing indicator             | 10. Temperature display                    |
| 4. Up-down swing indicator                | 11. Lock indicator                         |
| 5. Faceplate function indicator           | 12. Room temperature indicator             |
| 6. Main unit and secondary unit indicator | 13. Clock display                          |
| 7. Follow me function indicator           | 14. On/Off timer                           |
|   | 15. Timer display                          |

## 8. WIRED CONTROLLER BUTTONS

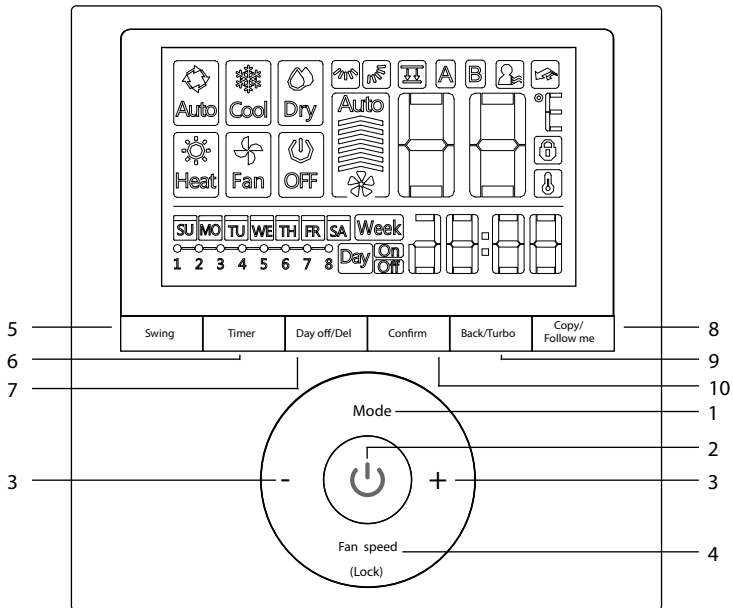



1. Mode
2. Power
3. Adjust
4. Fan Speed
5. Swing

6. Timer
7. Day Off/Del
8. Copy/Follow me
9. Back/Turbo
10. Confirm

## 9. PREPARATORY OPERATION

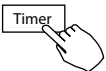
### Set the current day and time

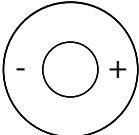
- 1  Press TIMER for 3s or more. The timer displays flashes.

- 2  Press + or - to set the date. The selected date flashes.
- 

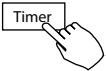
- 3  Date setting is complete and the time setting is ready after pressing TIMER or if nothing is pressed in 10 seconds.

- 4  Press + or - to set the current time. Press repeatedly to adjust the current time in 1 minute increments. Press and hold to adjust the current time.

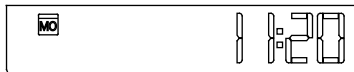

ex. Monday AM 11:20

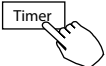
- 5  The setting is complete after pressing TIMER or if no button is pressed for 10 seconds.

## 10. OPERATION

---

### To start/stop operation



Press the Power button.

### To set the operation mode

#### Operation mode setting

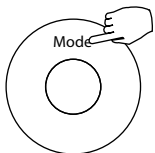

Press MODE to set the operation mode.  
(Heat function is invalid for cool only type unit)

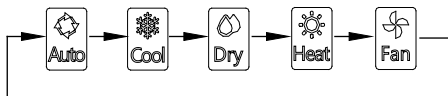

### Room temperature setting

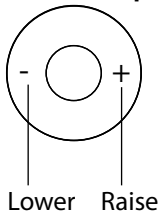

Press + or - to set the room temperature. Indoor  
Setting Temperature Range:  
62~86°F (17~30°C)/62~88°F (17~31°C (depending  
on models)).

## 10. OPERATION

### Fan speed setting

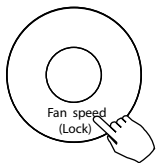

Press FAN SPEED to set the fan speed

NOTE: This function is unavailable in the AUTO or DRY modes.

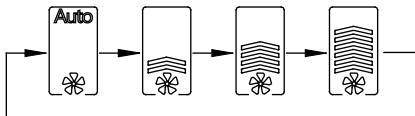

### Room temperature sensor selection

Press FOLLOW ME to select whether the room temperature is detected at the indoor unit or at the wired controller.

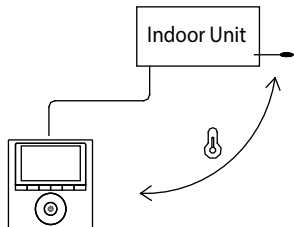
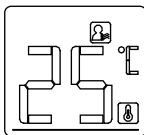
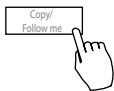

NOTE: When the FOLLOW ME function indication  appears, the room temperature is detected at the wire remote controller.

## 10. OPERATION

---

### Child lock function

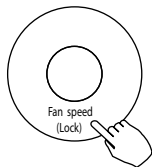

Press LOCK for 3 seconds to activate the CHILD LOCK feature and lock all buttons on the wired controller. Press again for 3 seconds to deactivate.

NOTE: When the child lock function is activated, the  lock image appears.

### keypad tone setting

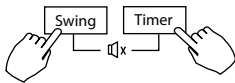

Press SWING and TIMER simultaneously for 3 seconds to disable the keypad tone. Press the buttons again for 3 seconds to enable the keypad tone.

### °C & °F scale selection (on some models)

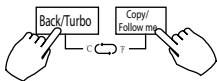

Press BACK and COPY simultaneously for 3 seconds to alternate the temperature display between the °F & °C scale.

## 10. OPERATION

### Turbo/Auxiliary Heat function (on some models)

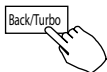

- Press TURBO to activate/deactivate the Turbo/Auxiliary Heat function. The turbo function sets the unit to reach the user's present temperature in the shortest amount of time possible.
- When the user presses TURBO in the COOL mode, the unit sets to the highest fan speed setting to jump-start the cooling process.
- When the user presses TURBO in the HEAT mode, for units with AUX. HEAT, the AUX. HEAT activates and jump-starts the heating process.

### Lift panel function (only for some cassette specific panel)

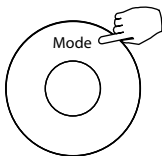

1. When the unit is off, Press the Mode button long to activate the lift panel function. The  mark will flash.

The F2 mark appears when the panel is adjusted.

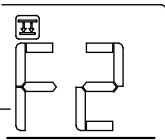

2. Press the button + and - to control the lift and drop of the panel. Pressing the + button can stop the panel, while it is dropping. Pressing the - button can stop the panel, while it is lifting.

## 10. OPERATION

---

### Swing function

(For the unit with left & right auto swing function only)

#### 1 Up-Down swing

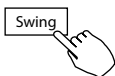

Press the Swing button to start up-down swing function.

Press it again to stop.

When the Up-Down swing function is activated, the  mark appears.

#### 2 Left-Right swing

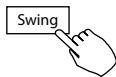

Press the Swing button long to start Left-Right swing function.

Press it again to stop.

When the Left-Right swing function is activated, the  mark appears.

## 10. OPERATION

### Swing function

(For the unit without left & right auto swing function models)

#### Up-Down airflow direction and swing

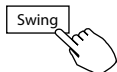

- Use SWING to adjust the up and down airflow direction.
  1. Every time the user presses SWING, the louver swings six degrees.
  2. Press and hold SWING for 2 seconds, it changes to the UP-DOWN SWING mode. Press SWING again to stop. When the Up-Down swing function is activated, the  mark appears. (Not applicable to all the models)
- The operation can refer to the following instructions for the unit with four Up-Down louvers can be operated individually.

1. Press the Swing button to activate the Up-Down adjusting louver function.

The  mark will flash. (Not applicable to all the models)

2. Pressing the button "+" or "-" can select the movement of four louvers. Each time you push the button, the wire controller select in a sequence that goes from: (the icon  means the four louvers move at the same time.)

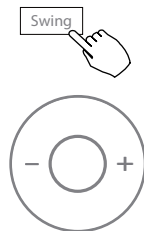
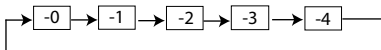

3. And then use Swing button to adjust the Up-Down airflow direction of the selected louver.

## 11. TIMER FUNCTIONS

---



WEEKLY timer

Use to set the operating times for each day of the week.



On timer

Use to start the air conditioner operation. The timer operates and the air conditioner operation starts after the time has passed.



Off timer

Use to stop the air conditioner operation. The timer operates and the air conditioner operation stops after the time has passed.



On and Off timer

Use to start and stop the air conditioner operation. The timer operates and the air conditioner operation starts and stops after the time has passed.

## 11. TIMER FUNCTIONS

### To set the On or Off TIMER

1



Press Timer to select the Day<sup>On</sup> or Day<sup>Off</sup>.



2



Press Confirm and the Clock display flashes

3

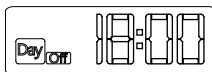
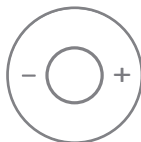

ex. Off timer set at PM 6:00

Press + or - to set the time. After the time is set, the timer starts or stops automatically.

4





Press Confirm again to finish the settings.

## 11. TIMER FUNCTIONS

---



### To set the On and Off TIMER

1  Press Timer to select the .

---

2  Press Confirm and the Clock display flashes.

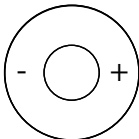
---

3   Press the button + or - to set the On timer and then press Confirm.

---

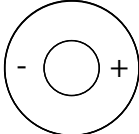
4  Press + or - to set the Off timer.

---

5  Press Confirm to finish the setting.

## 12. WEEKLY TIMER

### 1 Weekly timer setting



Press Timer to select the **Week** and press Confirm.

### 2 Day of the week setting

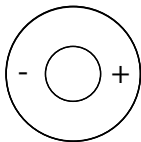

Press + or - to select the day of the week and then press CONFIRM.



### 3 ON timer setting of timer setting 1

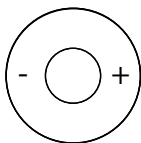

Press + and - to select the setting time. The setting time, mode, temperature and fan speed appear on the LCD. Press CONFIRM to enter the setting time process.

## 12. WEEKLY TIMER

**IMPORTANT:** Up to 8 scheduled events can be set on one day. Various events can be scheduled in either MODE, TEMPERATURE and FAN speeds.

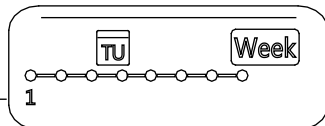

ex. Tuesday time scale 1

### 4 Time setting

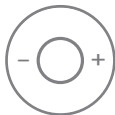

Press + and - to set the time then press CONFIRM.

### 5 Operation mode setting

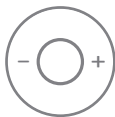

Press + and - to set the operation mode then press CONFIRM.

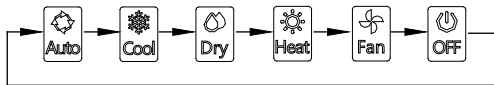

### 6 Room temperature setting



Press + and - to set the room temperature then press CONFIRM.

**NOTE:** This setting is unavailable in the FAN or OFF modes.

## 12. WEEKLY TIMER

---

### 7 Fan speed setting



Press + and – to set the fan speed then press CONFIRM.

NOTE: This setting is unavailable in the AUTO, DRY or OFF modes.

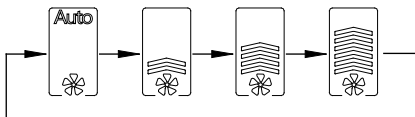

---

**8 Different scheduled events can be set by repeating steps 3 through 7.**

**9 Additional days, in a one week period, can be set by repeating steps 3 through 8.**

NOTE: The weekly timer setting can be returned to the previous step by pressing BACK. The current setting is restored. The controller will not save the weekly timer settings if there is no operation within 30 seconds.

## 12. WEEKLY TIMER

### WEEKLY timer operation

To start



Press Timer to select the **Week**, and then the timer starts automatically.

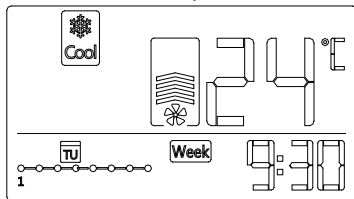

ex.

To cancel



Press Power to cancel the timer mode.



The timer mode can also be canceled by changing the timer mode using Timer.

### To set the DAY OFF (for a holiday)



After setting the weekly timer, press CONFIRM.

---



Press + or - to select the day of the week.

## 12. WEEKLY TIMER

3



Press DAY OFF to create an off day.

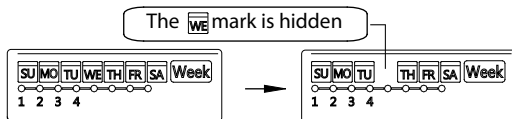

ex.The DAY OFF is set for Wednesday

4

Set the DAY OFF for other days by repeating the steps 2 and 3.

5



Press BACK to revert to the weekly timer.

- To cancel, follow the same procedures used for setup.
- NOTE: The DAY OFF setting is cancelled automatically after the set day has passed.

### Copy out the setting in one day into the other day.

- A scheduled event, made once, can be copied to another day of the week. The scheduled events of the selected day of the week will be copied. The effective use of the copy mode ensures the ease of reservation making.

1



In the weekly timer, press CONFIRM.

2



Press + or - to select the day to copy from.

## 12. WEEKLY TIMER

---

3

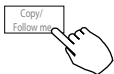

Press COPY, the letters CY appear on the LCD.

---

4



Press + or - to select the day to copy to.

---

5

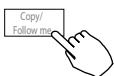

Press COPY to confirm.

The **WE** mark flashes quickly

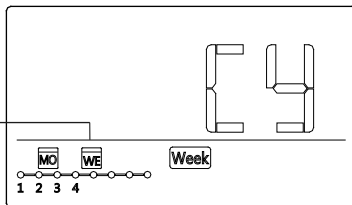

ex. Copy the setting of Monday to Wednesday

---

6

Other days can be copied by repeating steps 4 and 5.

---

7



Press CONFIRM to confirm the settings.

---

8



Press BACK to revert to the weekly timer.

---

## 12. WEEKLY TIMER

### Delete the time scale in one day.

**1**  During the weekly timer setting, press CONFIRM.

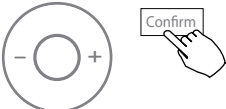
**2**  Press + and - to select the day of the week and then press CONFIRM.

**3** 

Press + and - to select the setting time want to delete. The setting time, mode, temperature and fan speed appear on the LCD. The setting time, mode, temperature and fan speed can be deleted by pressing the DEL (day off).

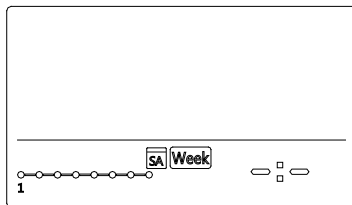
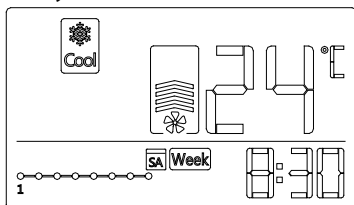

ex. Delete the time scale 1 in saturday

## 13. SET EXTERNAL STATIC PRESSURE

### Using the wire controller to set external static pressure (some air conditioners) .

- You can use the unit's automatic airflow adjustment function to set external static pressure.
  - Automatic airflow adjustment is the volume of blow-off air that has been automatically adjusted to the quantity rated.
1. Make sure the test run is done with a dry coil. If the coil is not dry, run the unit for 2 hours in FAN ONLY mode to dry the coil.
  2. Check that both power supply wiring and duct installation have been completed Check that any closing dampers are open.  
Check that the air filter is properly attached to the air suction side passage of the unit.
  3. Set the parameters for automatic airflow adjustment. When the air conditioning unit is off, perform the following steps:
    - Press "Copy" long.
    - Press "+" or "-" to select the AF.
    - Press "Confirm". The air conditioning unit will then start the fan for airflow automatic adjustment.

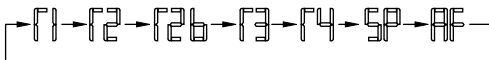

ON will flash during when the fan is on during automatic airflow adjustment.

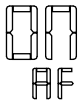

**DO NOT** adjust the dampers when automatic airflow adjustment is active.

After 3 to 6 minutes, the air conditioning unit stops operating once automatic airflow adjustment has finished.

### Using the wire controller to set airflow rate (some air conditioners) .

When the air conditioning unit is off, perform the following steps:

- Press "Copy" long.
  - Press "+" or "-" to select the SP.
  - Press "Confirm" to set the airflow.
- 0 means a stable airflow volume, 1 to 4 means an increase in airflow volume.
- Press "Back" to finish the setting.

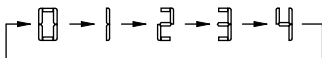

## 14. FAULT ALARM HANDLING

---

If the system does not properly operate except in the aforementioned cases or the aforementioned malfunctions are evident, investigate the system according to the following procedures.

NO.	MALFUNCTION AND PROTECTION DEFINITION	DISPLAY DIGITAL TUBE
1	Communication error between wired controller and indoor unit	F0
2	The faceplate is abnormal	F1

Please check the indoor unit's error display and review the owner's manual if other error codes appear.

## 15. TECHNICAL INDICATION AND REQUIREMENT

---

EMC and EMI comply with the CE certification requirements.

Page Intentionally Left Blank

Due to ongoing product improvements, specifications and dimensions are subject to change and correction without notice or incurring obligations. Determining the application and suitability for use of any product is the responsibility of the installer. Additionally, the installer is responsible for verifying dimensional data on the actual product prior to beginning any installation preparations.

Incentive and rebate programs have precise requirements as to product performance and certification. All products meet applicable regulations in effect on date of manufacture; however, certifications are not necessarily granted for the life of a product. Therefore, it is the responsibility of the applicant to determine whether a specific model qualifies for these incentive/rebate programs.

