



Multi-Position Hydronic Heat Copper Coil Air Handlers

HWCR
A2L Refrigerant Multi-Position Air Handler

Instruction Manual

CONTENT

1. Important Safety Instructions
2. Introduction & General Information
3. Inspection
4. General information & Installation Preparation
5. Installation Instructions & Clearances
6. Installation
7. Connecting Refrigerant Lines
8. Metering Devices / Liquid Line Connection
9. Leak Check / Standing Pressure Test / Vacuum Test
10. Electrical Line Voltage Wiring
11. Low Voltage Connections
12. Air Volume Adjustment
13. System Charging
14. Hydronic Heat
15. A2L Refrigerant Leak Detection Systems
16. Final System Checkout
17. Wiring Diagrams

1. IMPORTANT SAFETY INSTRUCTION

Potential safety hazards are alerted using the following symbols. The symbol is used in conjunction with terms that indicate the intensity of the hazard. It is the responsibility of the owner and the installer to read and comply with the safety information and the instructions accompanying these symbols.

 Read the precautions in this manual carefully before operating the unit.

 Read the instructions in this manual carefully before operating the unit.

 Read the instructions in this manual carefully before servicing the unit.

 Read the instructions in this manual carefully before wiring the unit.

 Warning or Caution

 **WARNING** This symbol indicates a potentially hazardous situation, which if not avoided, could result in serious injury, serious injury, property damage, product damage or death.

 **CAUTION** This symbol indicates a potentially hazardous situation, which if not avoided, may result in moderate injury or property damage.

 **WARNING** Certified technicians or those individuals meeting the requirements specified by NATE may use this information. Property and product damage or personal injury hazard may occur without such background.

This appliance is not intended for use by persons (including children) with reduced physical, sensory, or mental capabilities, or lack of experience and knowledge, unless they have been given supervision or instruction concerning use of the appliance by a person responsible for their safety. Children must be supervised to ensure that they do not play with the appliance.

Product designed and manufactured to permit installation in accordance with local and national building codes. It is the installer's responsibility to ensure that the product is installed in strict compliance with the aforementioned codes. Manufacturer assumes no responsibility for damage (personal, product or property) caused due to installations violating regulations.

 **WARNING** Disconnect ALL power before servicing or installing this unit. Multiple power sources may be present. Failure to do so may cause property damage, personal injury, or death.

 **WARNING** Unit is not approved for outdoor installations.

 **WARNING** **HAZARDOUS VOLTAGE!** Failure to follow this warning could result in property damage, severe personal injury, or death.

Disconnect ALL electric power, including remote disconnects before servicing. Follow proper lockout/tagout procedures to ensure the power cannot be inadvertently energized.

 **WARNING** The unit is designed for operation with 120 V, single phase, 60 Hz power supply. Aspen will NOT be responsible for damages caused due to modification of the unit to operate with alternative power sources.

 **WARNING** When this unit is installed in an enclosed area, such as a garage or utility room with any Carbon Monoxide producing devices (i.e. automobile, space heater, water heater etc.) ensure that the enclosed area is properly ventilated.

 **WARNING** This product designed and manufactured to permit installation in accordance with local and national building codes. It is the installer's responsibility to ensure that product is installed in strict compliance with national and local codes. Manufacturer takes no responsibility for damage (personal, product or property) caused due to installations violating regulations. Installation of this unit shall be made in accordance with the National Electric Code, NFPA No. 90A and 90B, and any other local codes or utilities requirements.

 **WARNING** Do not bypass safety devices.

 **WARNING** **RISK OF FIRE!** Flammable refrigerant used. To be repaired only by trained service professional. Do not puncture refrigerant tubing. Dispose of properly in accordance with local regulations. Flammable refrigerant used.

 **WARNING** **PRESSURIZED REFRIGERANT!** Failure to follow this warning could result in personal injury. System contains oil and refrigerant under high pressure. Recover refrigerant before opening the system. Do not use non-approved refrigerants or refrigerant substitutes or refrigerant additives.

 **WARNING** If any hot work is to be conducted on the refrigerating equipment or an associated parts, appropriate fire extinguishing equipment shall be available to hand. Have a dry powder or CO2 fire extinguisher adjacent to the charging area.

 **CAUTION** Only factory authorized kits and accessories should be used when installing or modifying this unit unless it is so noted in these instructions. Some localities may require a licensed installer/service personnel.

 **WARNING** This product can expose you to chemicals including lead, which are known to the State of California to cause cancer and birth defects or other reproductive harm. For more information go to www.p65Warnings.ca.gov.

 **WARNING** DO NOT use means to accelerate the defrosting process or to clean, other than those recommended by the manufacturer.

The appliance shall be stored in a room without continuously operating ignition sources (for example: open flames, an operating gas appliance or an operating electric heater).

Do not pierce or burn. Be aware that refrigerants may not contain an odor.

- This appliance shall be installed in accordance with national wiring regulations.
- The of the space necessary for correct installation of the appliance including the minimum permissible distance to adjacent structures is specified in Section 5 of this manual under "INSTALLATION INSTRUCTIONS AND CLEARANCES".
- For air handlers with supplementary heaters, the minimum clearance from the appliance to combustible surfaces is specified in Section 5 of this manual under "INSTALLATION INSTRUCTIONS AND CLEARANCES", the equipment was tested for 0" clearance.
- A wiring diagram with clear indication of the connections to external control devices and supply cord can be found in Section 17 of this manual.
- The range of external static pressure at which the appliance was tested (add-on heat pumps and ducted appliances with supplementary heaters only) is available in Section 12 of this manual.
- The method of connecting the appliance to the electrical supply and interconnection of separate components is detailed in Section 11, LOW VOLTAGE CONNECTIONS and in Section 17, WIRING DIAGRAMS.
- None of the components in this product family are designed or approved to be suitable for outdoor use.
- Refer to Section 14 of this manual for details of Electric Heat Kits that may be used in conjunction with the appliance, field installed heater kit fitting/ installation instructions are supplied with the heater kits.

This Air Handler unit is a **PARTIAL UNIT AIR CONDITIONER**, complying with **PARTIAL UNIT** requirements of Standard UL 60335-2-40/CSA 22.2 NO. 60335-2-40, and must only be connected to other units that have been confirmed as complying to corresponding **PARTIAL UNIT** requirements of this Standard.

This appliance is not intended for use at altitudes exceeding 2,000 meters.

2. INTRODUCTION & GENERAL INFORMATION

These air handlers are versatile multi-positional unit with the following standard features:

- **APPLICATION VERSATILITY:** This unit is designed for use in upflow, downflow, horizontal left, and horizontal right applications. Follow

Section 5 & 6 for installation and conversion instructions.

Can be AHRJ matched with most brands of air conditioners or heat pumps outdoor sections **R32 or R454B REFRIGERANT** when proper metering device is used.

Product design for use with A2L refrigerant are marked with R32 or R454B refrigerant specified on the nameplate, and the product will be marked with the following symbols:



FIGURE 2.1

Product design for use with A2L refrigerant are equipped with an A2L refrigerant detection system (RDS), which includes A2L Sensor, Mitigation Control Board, and Wiring Harnesses. Refer to Section 15 of this manual wiring and operation instructions.

- **MOTOR: HWCR*X models:** Constant torque ECM speeds and torques are controlled by software embedded in the motor to maintain constant torque. Motors are pre-programmed at the factory. **HWCR*T models:** are equipped with a 120-volt PSC motor.
- **CABINET:** Sturdy, short, galvanized steel cabinet with painted front panels. Cabinet fully insulated with 1/2" faced insulation to prevent sweating, to encapsulate glass fibers, and to provide excellent R-value. Stick pins ensure insulation remains in place. Units ship with disposable filter in filter rack.
- **Hydronic Coil:** Available with either circuit breakers or terminal blocks. Hydronic Coils come in 2, 3 and 4 row with the options of pump or no pump configurations.
- **BLOWER:** Direct drive multi-speed blowers circulate air quietly and efficiently. Motor speeds can be easily selected via motor terminals. Swing mounted blowers can be easily removed for service.
- **ELECTRONIC CIRCUIT BOARD:** Electronic circuit board provides 30 sec. ON/OFF blower time delay extracting more heat/cool from the coil.
- **DX Coil:** High efficiency rifled copper tubes and enhanced aluminum fins provide maximum heat transfer. All coils factory leak tested with two-stage pressure decay and mass spectrometer process then nitrogen pressurized, and factory sealed for maximum reliability. Coil mounted Schrader allows pre-installation pressure testing.
Available with either check style flowrator or TXV metering device. Field-installable TXVs are also available.
Rugged GLP drain pan holds minimal condensate while eliminating the possibility of corrosion. Drain pans are UV safe. GLP drain pans with bottom primary and secondary drain connections or alternate right-side primary. All connections 3/4" FPT. Access door allows for coil cleaning.
- **WARRANTY:** Five-year limited parts warranty.

3. INSPECTION

On receiving the product, visually inspect it for any major shipping related damages. Shipping damages are the carrier's responsibility. Inspect the product labels to verify the model number and options are in accordance with your order. Manufacturer will **NOT** accept damage claims for incorrectly shipped product.

4. GENERAL INFO. AND INSTALLATION PREPARATION

Read all the instructions in this guideline carefully while paying special attention to the WARNING and CAUTION alerts. If any of the instructions are unclear; clarify with certified technicians. Gather all the tools needed for successful installation of the unit prior to beginning the installation.

Information for Installation, Service, Maintenance & Repair Instructions.

Products designed for use with A2L / Flammable Refrigerants are equipped with a refrigerant leak detection system (which includes an A2L Sensor, a Mitigation Control Board, and Harnesses) which must be wired to the furnace as specified in the Wiring Diagram.

The A2L Sensor must be installed and powered for service.

WARNING When using **FLAMMABLE REFRIGERANTS**, **LEAK DETECTION SYSTEM** installed. Unit must be powered except for service.

For mechanical ventilation, the lower edge of the air extraction opening where air is exhausted from the room shall not be more than 100 mm above the floor. The location where the mechanical ventilation air extracted from the space is discharged shall be separated by a sufficient distance, but not less than 3 m, from the mechanical ventilation air intake openings, to prevent recirculation to the space.

WARNING Refrigerating pipe or components are installed in a position where they are unlikely to be exposed to any substance which may corrode refrigerant containing components, unless the components are constructed of materials which are inherently resistant to being corroded or are suitably protected against being so corroded.

False ceilings or drop ceilings may be used as a return air plenum only if a refrigerant detection system is provided in the appliance and any external connections are also provided with a sensor immediately below the return air plenum duct joint.

WARNING RISK OF FIRE! Auxiliary devices which may be a **POTENTIAL IGNITION SOURCE** shall not be installed in the duct work. Examples of such **POTENTIAL IGNITION SOURCES** are hot surfaces with a temperature exceeding 700°C and electric switching devices.

WARNING Only auxiliary devices approved by the appliance manufacturer or declared suitable with the refrigerant shall be installed in connecting ductwork.

4.1. QUALIFICATION OF WORKERS

Only technicians with training carried out by national training organizations or manufacturers that are accredited to teach the relevant national competency standards that may be set in legislation may work on this equipment. The achieved competence must be documented by a certificate.

4.2. CHECKS TO THE WORK AREA AND WORK PROCEDURE

Prior to work taking place, the area around the equipment is to be surveyed to make sure that there are no flammable hazards or ignition risks.

Work shall be undertaken under a controlled procedure so as to minimize the risk of a flammable gas or vapor being present while the work is being performed.

All maintenance staff and others working in the local area shall be instructed on the nature of work being carried out. Work in confined spaces shall be avoided.

4.3. CHECKING FOR PRESENCE OF REFRIGERANT

The area shall be checked with an appropriate refrigerant detector prior to and during work, to ensure the technician is aware of potentially toxic or flammable atmospheres.

Ensure that the leak detection equipment being used is suitable for use with all applicable refrigerants, i.e. non-sparking, adequately sealed or intrinsically safe.

4.4. PRESENCE OF FIRE EXTINGUISHER

If any hot work is to be conducted on the refrigerating equipment or any associated parts, appropriate fire extinguishing equipment shall be available to hand. Have a dry powder or CO2 fire extinguisher adjacent to the charging area.

4.5. NO IGNITION SOURCES

No person carrying out work in relation to a REFRIGERATING SYSTEM which involves exposing any pipe work shall use any sources of ignition in such a manner that it may lead to the risk of fire or explosion. All possible ignition sources, including cigarette smoking, should be kept sufficiently far away from the site of installation, repairing, removing and disposal, during which refrigerant can possibly be released to the surrounding space. Prior to work taking place, the area around the equipment is to be surveyed to make sure that there are no flammable hazards or ignition risks. "NO SMOKING" signs shall be displayed.

4.6. VENTILATED AREA

Ensure that the area is in the open or that it is adequately ventilated before breaking into the system or conducting any hot work. A degree of ventilation

WARNING Disconnect ALL power before servicing or installing this unit. Multiple power sources may be present. Failure to do so may cause property damage, personal injury, or death

shall continue during the period that the work is carried out. The ventilation should safely disperse any released refrigerant and preferably expel it externally into the atmosphere.

4.7. CHECKS TO REFRIGERATING EQUIPMENT

Where electrical components are being changed, they shall be fit for the purpose and to the correct specification. At all times the manufacturer's maintenance and service guidelines shall be followed. If in doubt, consult the manufacturer's technical department for assistance.

The following checks shall be applied to installations using **FLAMMABLE REFRIGERANTS**:

- The actual **REFRIGERANT CHARGE** is in accordance with the room size within which the refrigerant containing parts are installed;
- The ventilation machinery and outlets are operating adequately and are not obstructed;
- Marking to the equipment continues to be visible and legible. Markings and signs that are illegible shall be corrected;
- Refrigerating pipe or components are installed in a position where they are unlikely to be exposed to any substance which may corrode refrigerant containing components, unless the components are constructed of materials which are inherently resistant to being corroded or are suitably protected against being so corroded.

4.8. CHECKS TO ELECTRICAL DEVICES

Repair and maintenance to electrical components shall include initial safety checks and component inspection procedures. If a fault exists that could compromise safety, then no electrical supply shall be connected to the circuit until it is satisfactorily dealt with. If the fault cannot be corrected immediately but it is necessary to continue operation, an adequate temporary solution shall be used. This shall be reported to the owner of the equipment so all parties are advised.

Initial Safety Checks shall include:

- That capacitors are discharged: this shall be done in a safe manner to avoid possibility of sparking;
- That no live electrical components and wiring are exposed while charging, recovering or purging the system;
- That there is continuity of earth bonding.

4.9. REPAIRS TO SEALED ELECTRICAL COMPONENTS

During repairs to sealed electrical components, all electrical supplies shall be disconnected from the equipment being worked upon prior to any removal of sealed covers, etc. If it is absolutely necessary to have an electrical supply to equipment during servicing, then a permanently operating form of leak detection shall be located at the most critical point to warn of a potentially hazardous situation.

Particular attention shall be paid to the following to ensure that by working on electrical components, the casing is not altered in such a way that the level of protection is affected. This shall include damage to cables, excessive number of connections, terminals not made to original specification, damage to seals, incorrect fitting of glands, etc.

Ensure that the apparatus is mounted securely.

Ensure that seals or sealing materials have not degraded to the point that they no longer serve the purpose of preventing the ingress of flammable atmospheres. Replacement parts shall be in accordance with the manufacturer's specifications.

4.10. CABLING

Check that cabling will not be subject to wear, corrosion, excessive pressure, vibration, sharp edges or any other adverse environmental effects. The check shall also take into account the effects of aging or continual vibration from sources such as compressors or fans.

4.11. DETECTION OF FLAMMABLE REFRIGERANTS

Under no circumstances shall potential sources of ignition be used in the searching for or detection of refrigerant leaks. A halide torch (or any other detector using a naked flame) shall not be used.

Electronic leak detectors may be used to detect refrigerant leaks but, in the case of FLAMMABLE REFRIGERANTS, the sensitivity may not be adequate, or may need re-calibration. (Detection equipment shall be calibrated in a refrigerant-free area.) Ensure that the detector is not a potential source of ignition and is suitable for the refrigerant used. Leak detection equipment shall

be set at a percentage of the LFL of the refrigerant and shall be calibrated to the refrigerant employed, and the appropriate percentage of gas (15 % maximum) is confirmed.

Leak detection fluids such as the bubble method is also suitable for use with most refrigerants but the use of detergents containing chlorine shall be avoided as the chlorine may react with the refrigerant and corrode the copper pipe-work. If a leak is suspected, all naked flames shall be removed/extinguished. If a leakage of refrigerant is found which requires brazing, all of the refrigerant shall be recovered from the system, or isolated (by means of shut off valves) in a part of the system remote from the leak.

4.12. REMOVAL AND EVACUATION

When breaking into the refrigerant circuit to make repairs – or for any other purpose – conventional procedures shall be used. However, for FLAMMABLE REFRIGERANTS it is important that best practice is followed since flammability is a consideration. The following procedure shall be adhered to:

- safely remove refrigerant following local and national regulations;
- evacuate;
- purge the circuit with inert gas (optional for A2L);
- evacuate (optional for A2L);
- continuously flush or purge with inert gas when using flame to open circuit; and
- open the circuit.

The refrigerant charge shall be recovered into the correct recovery cylinders if venting is not allowed by local and national codes. For appliances containing flammable refrigerants, the system shall be purged with oxygen-free nitrogen to render the appliance safe for flammable refrigerants. This process might need to be repeated several times. Compressed air or oxygen shall not be used for purging refrigerant systems.

For appliances containing flammable refrigerants, refrigerant purging shall be achieved by breaking the vacuum in the system with oxygen-free nitrogen and continuing until the working pressure is achieved, then venting to the atmosphere, and finally pulling down to a vacuum (optional for A2L). This process shall be repeated until no refrigerant is within the system (optional for A2L). When the final oxygen-free nitrogen charge is used, the system shall be vented down to atmospheric pressure to enable work to take place.

The outlet for the vacuum pump shall not be close to any potential ignition sources, and ventilation shall be available.

4.13. CHARGING PROCEDURES

In addition to conventional charging procedures, the following requirements shall be followed.

- Ensure that contamination of different refrigerants does **not** occur when using charging equipment.
- Hoses or lines shall be as short as possible to minimize the amount of refrigerant contained in them.
- Cylinders shall be kept in an appropriate position according to the instructions.
- Ensure that the REFRIGERATING SYSTEM is earthed prior to charging the system with refrigerant.
- Label the system when charging is complete (if not already).
- Extreme care shall be taken not to overfill the REFRIGERATING SYSTEM.

Prior to recharging the system, it shall be pressure-tested with the appropriate purging gas. The system shall be leak-tested on completion of charging but prior to commissioning. A follow up leak test shall be carried out prior to leaving the site.

4.14. DECOMMISSIONING

Before carrying out this procedure, it is essential that the technician is completely familiar with the equipment and all its detail. It is recommended good practice that all refrigerants are recovered safely. Prior to the task being carried out, an oil and refrigerant sample shall be taken in case analysis is required prior to re-use of recovered refrigerant. It is essential that electrical power is available before the task is commenced.

- A) Become familiar with the equipment and its operation.
- B) Isolate system electrically.
- C) Before attempting the procedure, ensure that:

- mechanical handling equipment is available, if required, for handling refrigerant cylinders;
- all personal protective equipment is available and being used correctly;
- the recovery process is supervised at all times by a competent person;
- recovery equipment and cylinders conform to the appropriate standards.

- D) Pump down refrigerant system, if possible.
- E) If a vacuum is not possible, make a manifold so that refrigerant can be removed from various parts of the system.
- F) Make sure that cylinder is situated on the scales before recovery takes place.
- G) Start the recovery machine and operate in accordance with instructions.
- H) **Do not** overfill cylinders (no more than 80 % volume liquid charge).
- I) **Do not** exceed the maximum working pressure of the cylinder, even temporarily.
- J) When the cylinders have been filled correctly and the process completed, make sure that the cylinders and the equipment are removed from site promptly and all isolation valves on the equipment are closed off.
- K) Recovered refrigerant shall not be charged into another REFRIGERATING SYSTEM unless it has been cleaned and checked.

4.15. LABELING

Equipment shall be labeled stating that it has been decommissioned and emptied of refrigerant. The label shall be dated and signed. For appliances containing FLAMMABLE REFRIGERANTS, ensure that there are labels on the equipment stating that the equipment contains FLAMMABLE REFRIGERANT.

4.16. RECOVERY

When removing refrigerant from a system, either for servicing or decommissioning, it is recommended good practice that all refrigerants are removed safely.

When transferring refrigerant into cylinders, ensure that only appropriate refrigerant recovery cylinders are employed. Ensure that the correct number of cylinders for holding the total system charge is available. All cylinders to be used are designated for the recovered refrigerant and labeled for that refrigerant (i.e. special cylinders for the recovery of refrigerant). Cylinders shall be complete with pressure-relief valve and associated shut-off valves in good working order. Empty recovery cylinders are evacuated and, if possible, cooled before recovery occurs.

The recovery equipment shall be in good working order with a set of instructions concerning the equipment that is at hand and shall be suitable for the recovery of the flammable refrigerant. If in doubt, the manufacturer should be consulted. In addition, a set of calibrated weighing scales shall be available and in good working order. Hoses shall be complete with leak-free disconnect couplings and in good condition.

The recovered refrigerant shall be processed according to local legislation in the correct recovery cylinder, and the relevant waste transfer note arranged. Do not mix refrigerants in recovery units and especially not in cylinders.

If compressors or compressor oils are to be removed, ensure that they have been evacuated to an acceptable level to make certain that flammable refrigerant does not remain within the lubricant. The compressor body shall not be heated by an open flame or other ignition sources to accelerate this process. When oil is drained from a system, it shall be carried out safely.

5. INSTALLATION INSTRUCTIONS AND CLEARANCES

This unit is designed for zero clearance installation on three sides and adequate clearance to provide access for service in the front. A minimum of 2.5 – 3.5 feet clearance is recommended on the front end (Fig 5.1).

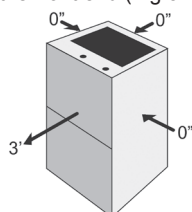

FIGURE 5.1
INSTALLATION CLEARANCE

5.1. MOUNTING OPTION

If the unit is to be installed in garages, warehouses or other areas where they may be subjected to physical damage, adequate protective barriers must be installed. Unit must be installed 18" away from source of ignition.

If the unit is located in high humidity areas like attics or unconditioned garage; the air handler casing might experience nuisance sweating. In such installation scenarios, wrapping the casing with a 2" fiberglass insulation with vapor barrier should be used.

5.2. CONDENSATE DRAIN PREPARATION

5.2.1. CONDENSATE DRAIN

- Condensate drain is located at front as shown in picture with primary and secondary drain port.
- Pipe condensate system using proper PVC fittings.
- Ensure a minimum 2" trap is installed in the condensate drain. Locate the trap near to the connection opening on the air handler. See illustration.



FIGURE 5.2A
CONDENSATE
DRAIN TRAP

An auxiliary drain pan must be provided by the installer and placed under the entire unit with a separate drain line that is properly sloped and terminated in an area visible to the homeowner. The auxiliary pans provide extra protection to the area under the unit should the primary and secondary drain plug up and overflow. As expressed in our product warranty; **ASPEN WILL NOT BE BILLED FOR ANY STRUCTURAL DAMAGES CAUSED BY FAILURE TO FOLLOW THIS INSTALLATION REQUIREMENT.** The drains from the auxiliary drain pan must be installed according to the local building codes.



CAUTION

Drain lines from the auxiliary drain pan should **NOT** be connected to the primary drain line of the coil.

The drain lines must be installed with 1/4" per foot pitch to provide free drainage. A condensate trap **MUST** be installed on the primary drain line to ensure proper drainage of the condensate. The trap must be installed in the drain line below the bottom of the drain pan (Fig. 5.2b)

FIGURE 5.2B
CONDENSATE
DRAIN TRAP

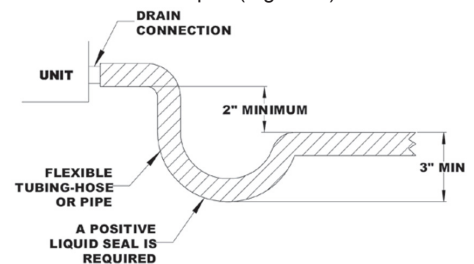

CAUTION

Since coil is upstream of the blower, all drains **MUST** be trapped or sealed. Failure to do so will result in condensate overflow from the drain pan.

Aspen will **NOT** be responsible for any damages resulting from failure to follow these instructions.



CAUTION

If the drain pan is constructed of nylon or plastic; use Teflon tape to connect the drain lines to the threads in the drain pan. **DO NOT USE SOLVENT BASED PIPE DOPE. THIS WILL REDUCE THE LIFE OF THE PAN.**

The drain pan has primary and secondary drain connections. If a secondary drain line is required, it should be run separately from the primary and should terminate in a highly visible location.

Condensate disposal through the secondary drain line indicates that the primary drain line is plugged and needs cleaning. If a secondary drain line will not be provided, plug the secondary drain. Drain plugs are **NOT** to be reused without plumbers' tape or putty. Drain line connection should be finger tightened, then turned no more than one complete turn as needed to ensure a firm connection. **DO NOT** over-tighten connection or damage may occur.

5.3. DUCTWORK

Duct systems should be installed in accordance with standards for air-conditioning systems, National Fire Protection Association Pamphlet No. 90A or 90B. They should be sized in accordance with National Environmental System Contractors Association Manual K, or whichever is applicable.



On any job, non-flammable flexible collars should be used for the return air and discharge connections to prevent transmission of vibration (Fig 5.3). Although these units have been specially designed for quiet vibration-free operation, air ducts can act as soundboards, can, if poorly installed, amplify the slightest vibration to the annoyance level.

All main supply and return air drops should be properly sized as determined by the designer of the duct system and should not necessarily be the size of the duct flange openings of the unit. (The duct size should never be smaller than the flange openings of the air handler supply and return air openings.)

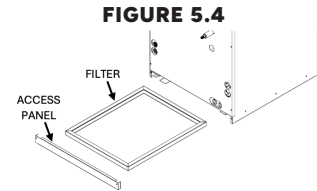

Filter sizes vary for each model (see spec sheet) that needs to be installed in the filter rack that is provided (Fig 5.4). Inspect and clean or replace filter every month. A blocked filter reduce airflow to the coil and hinder the performance of the system.

It is recommended that wherever supply and return air sheet metal duct PASS through unconditioned areas, they be insulated to prevent excessive heat loss during heating operation. When applied in conjunction with summer air conditioning, sheet metal duct routed through unconditioned areas should be insulated and have an outside vapor barrier to prevent formation of condensation.

6. INSTALLATION

- CAUTION** Ensure that the unit is adequately sized. The tonnage of the outdoor unit should never exceed the tonnage of this unit.
- WARNING** The coil was manufactured with a dry nitrogen pre-charge. Release the pressure through the Schrader valve test port prior to installation. If holding pressure is not present, return coil to distributor for exchange.
- CAUTION** Some Aspen coils may include a Schrader valve on the suction manifold. Ensure that the Schrader valve and valve core (where present) are protected from heat during brazing and installation to prevent leakage. Use a core removal tool to temporarily remove the core when brazing. Replace the core once brazing is completed.
- CAUTION** Insulation on the suction line **MUST** extend into the cabinet and continue as far as possible to eliminate condensate dripping onto the access door.

- ✓ Clean coil fins with degreasing agent or mild detergent and rinse fins clean prior to installation.
- ✓ The refrigerant line sizes should be selected according to the recommendations of the outdoor unit manufacturer.
- ✓ Care must be taken to ensure all connection joints are burr-free and clean. Failure to do so may increase chances of a leak. It is recommended to use a pipe cutter to remove the spun closed end of the suction line.
- ✓ To reduce air leakage, rubber grommets may be present where the lines pass through the coil case. To avoid damage, remove grommets prior to brazing by sliding over the lines. Use a quenching cloth or allow the lines to cool before reinstalling the grommets.
- ✓ Use of wet rags/quenching cloth is highly recommended to prevent weld-related damages to the casing and Schrader valve (if present).

6.1. AIR HANDLER ORIENTATION

This unit can be installed in upflow, counterflow, horizontal right and horizontal left discharge. See Fig. 6.1-A

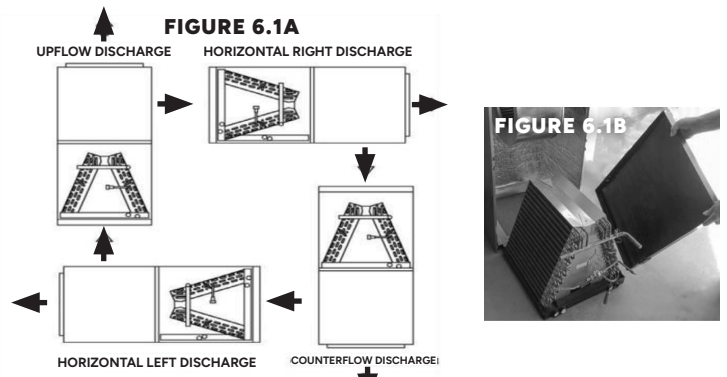

When installing in an upflow or counterflow discharge it is recommended to remove the horizontal drain pan that comes with the unit. See Fig 6.1-B.

6.1.1. HORIZONTAL LEFT-HAND DISCHARGE CONVERSION

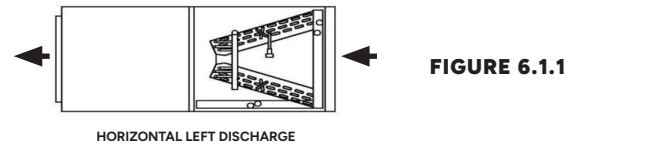

- | | |
|--|--|
| 1. Remove all access panels. | |
| 2. Pull out the coil and remove the horizontal drain pan. | |
| 3. Install the horizontal drain pan that was pulled out to the left-hand side of the coil. | |
| 4. Re-install the coil back to the cabinet and mount the access panels back into the unit. | |

6.1.2. COUNTERFLOW OR DOWNFLOW CONVERSION

A downflow kit (DFK) is required for counter/downflow air handler installation. See Table 6.1 for various downflow kit.

TABLE 5.1 DOWNFLOW KITS		
DOWNFLOW KIT	MODEL	STYLE
DFK-2	HWCR24T0A	1
DFK-3	HWCR23T0A	1
DFK-5	HWCR30X0A	1
DFK-6	HWCR35T0A	2
DFK-7	HWCR36T0A / HWCR35X0A	1
DFK-9	HWCR42X0A / HWCR48X0A	1
DFK-10	HWCR47T0A / HWCR59T0A HWCR47X0A / HWCR59X0A	2
DFK-11	HWCR48T0A	1
DFK-12	HWCR60X0A	1

1. Unscrew and open the access panels – upper (1), lower (2) and filter cover (3). Pull-out the filter (4), coil assembly (5) and discard horizontal pan (6) then unscrew the coil deck (7) and filter rail (8) on both sides of the cabinet before pulling out as shown in figure below.

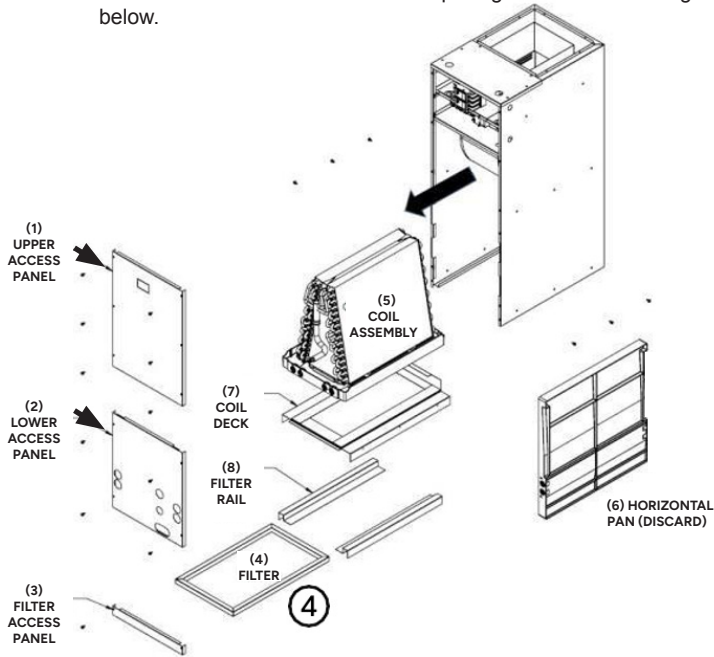

2. Rotate the unit 180° as shown in the figure.

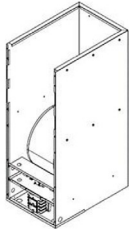

3. Re-install the coil deck (7), filter rail (8) and filter (4) as shown in figure below.

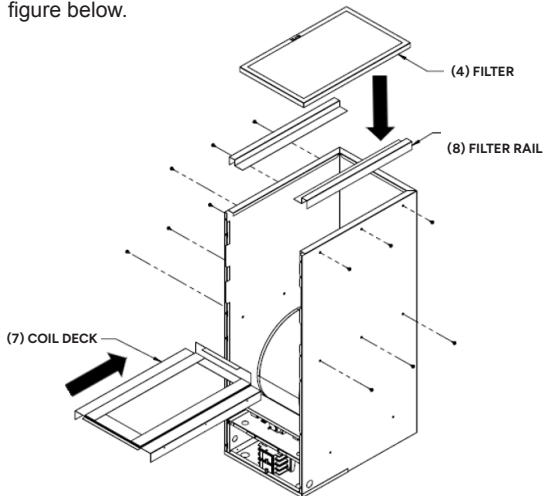

4. Add Block Off Plate (9) on coil assembly (5).

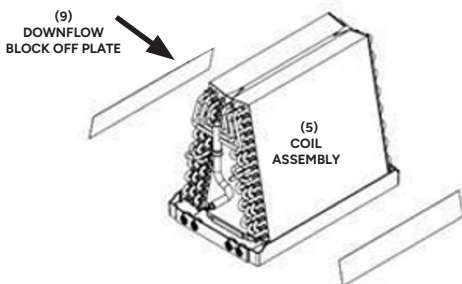

5. Slide the coil assembly (5) back into the cabinet then finally re-install and fasten all the access panels – filter cover (3), lower (2), and upper (1) as shown in figure below.

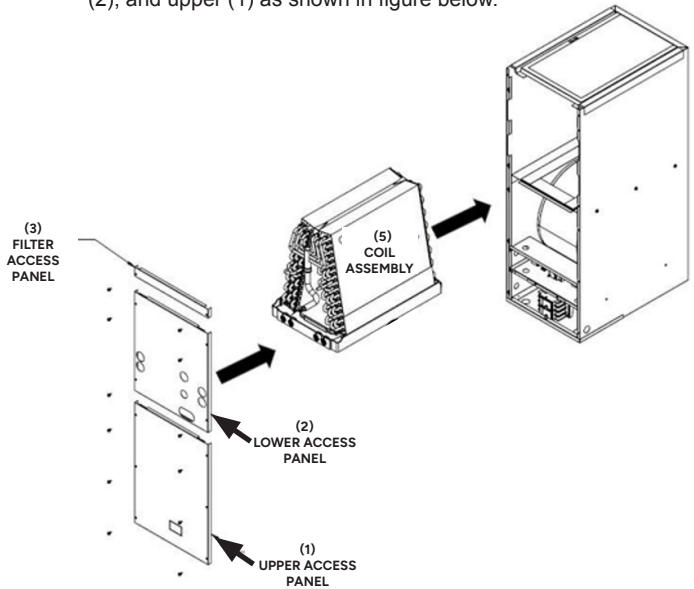

6.2. CONNECTING DUCTING

6.2.1. Secure supply air ducting to the top of the air handler. Canvas connectors are recommended for reducing potential noise transmission.

7. CONNECTING REFRIGERANT LINES

⚠ WARNING The coil is manufactured with dry nitrogen pre-charge. Release the pressure through the Schrader valve test port prior to installation. If holding pressure is not present, return coil to distributor for exchange.

⚠ NOTICE Refrigerant tubing must be routed to allow accessibility for service and maintenance of the unit.

Pipe-work including piping material, pipe routing, and installation shall include protection from physical damage in operation and service, and be in compliance with national and local codes and standards, such as ASHRAE 15, ASHRAE 15.2, IAPMO Uniform Mechanical Code, ICC International Mechanical Code, or CSA B52. All field joints shall be accessible for inspection prior to being covered or enclosed.

⚠ WARNING For coils using A2L FLAMMABLE REFRIGERANTS, when installed in a room with an area less than that outlined in Table 15.1 for R32 and Table 15.2 for R454B. That room shall be without continuously operating open flames (for Example an operating gas appliance) or other potential ignition sources (for example an operating electric heater, hot surfaces). A flame providing device that may be installed in the same space if the device is provided with an effective flame arrest.

After completion of field piping for split systems, the field pipework shall be pressure tested with an inert gas and then vacuum tested prior to refrigerant charging, according to the following requirements:

The minimum test pressure for the low side of the system shall be the low side design pressure and the minimum test pressure for the high side of the system shall be the high side design pressure, unless the high side of the system, cannot be isolated from the low side of the system in which case the entire system shall be pressure tested to the low side design pressure.

Field-made refrigerant joints indoors shall be tightness tested. The test method shall have a sensitivity of 5 grams per year of refrigerant or better under a pressure of at least 0.25 times the maximum allowable pressure. No leak shall be detected. **REFER TO SECTION 13 FOR SYSTEM CHARGING INSTRUCTIONS.**

Clean coil fins with degreasing agent or mild detergent and rinse fins clean prior to installation. **REFER TO SECTION 10 OF THIS MANUAL FOR COIL CLEANING / MAINTENANCE GUIDANCE.**

The refrigerant line sizes should be selected according to the

recommendations of the outdoor unit manufacturer.

Care must be taken to ensure all connection joints are burr-free and clean. Failure to do so may increase chances of a leak. It is recommended to use a pipe cutter to remove the spun closed end of the suction line.

To reduce air leakage, rubber grommets may be present where the lines pass through the coil case. To avoid damage, remove grommets prior to brazing by sliding over the lines. Use a quenching cloth or allow the lines to cool before reinstalling the grommets.

Use of wet rags/quenching cloth is highly recommended to prevent weld-related damage to the casing and Schrader valve (if present).

WARNING The coils may include a Schrader valve on the suction manifold. Ensure that the Schrader valve and valve core (where present) are protected from heat to prevent leakage.

7.1. Release nitrogen holding charge by depressing the Schrader Valve at the liquid line connection on the air handler. If no gas releases from the air handler, contact distributor regarding potential leak.



7.2. Cut off Schrader Valve fitting at the liquid line connection. Use a tubing cutter for this step. Clean the burr from the cut tubing to reduce the chance of future leaks. Connect the liquid line to the tubing at the indoor unit.



7.3. Use tubing cutter to remove the spun end from the suction line connection at the air handler. Clean the burr from the cut tubing to reduce the chance of future leaks.



7.4. To avoid heat damage to grommets where present, remove these prior to brazing by sliding them over the refrigerant lines and out of the way.

7.5. Check to determine if the evaporator coil has a Schrader fitting on the suction manifold. If yes, remove the valve core to prevent heat damage during brazing. Replace the valve core once the piping has cooled.

7.6. If the air handler has a TXV metering device, remove the sensing bulb from the suction line prior to brazing to prevent heat damage from occurring. Replace the sensing bulb once the piping has cooled.

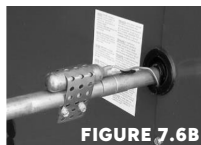

7.7. Flow nitrogen through the piping when brazing.

7.8. Braze both refrigerant line connections using proper brazing procedures.

7.9. When all line connections are brazed, perform a proper system evacuation procedure per the outdoor unit manufacturer instructions.



7.10. Seal the penetration openings where the line-set piping enters the air handler cabinet.

8. METERING DEVICES/LIQUID LINE CONNECTION

Aspen coils are available with two types of expansion / metering devices: a) flowrator / fixed orifice piston, or b) TXV. The following instructions are separated into sections by metering device.

Aspen's A2L air handlers can be factory configured or field-configured for R454B, or R-32 with the appropriate metering device (piston/fixed orifice or TXV) and can be equipped with factory or field installed Refrigerant Detection System Kit.

Field-configurable A2L coils will ship with a factory installed piston. For field-configuration:

- First confirm if the outdoor unit is factory charged with R454B or R32 refrigerant.

- Next, select the appropriate expansion device for the refrigerant used in the application and AHRI rating (if applicable).
 - o If installing a fixed orifice piston as the metering device, use the piston supplied by the outdoor unit's manufacturer with the outdoor unit. If a piston is not supplied with the outdoor unit, review the metering devices in Table 8.1 to ensure that the correct piston / fixed orifice size is installed. Follow installation instructions in Section 8.1.
 - o If installing a TXV as the metering device, review the metering devices in Table 8.1 to ensure that the correct TXV is installed. Follow installation instructions in Section 8.2.

FIGURE 8A

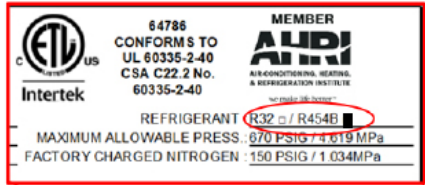
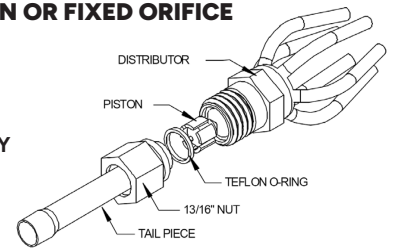

TABLE 8.1 - METERING DEVICES WITHOUT PISTON SUPPLIED								
TON.	R32 ORIF.		R32 TXV		R454B ORIF.		R454B TXV	
	SIZE	PART #	TXV KIT	PART #	SIZE	PART #	TXV KIT	PART #
1.5	0.042	4105	X32S	70014	0.045	4033	X454S	70011
2.0	0.049	4006			0.052	4007		
2.5	0.053	3978			0.059	4000		
3.0	0.057	3984			0.065	3980		
3.5	0.063	3973	X32L	70015	0.070	3993	X454L	70012
4.0	0.065	3980			0.076	3989		
5.0	0.074	4001			0.077	3995		

8.1 FLOWRATOR / PISTON OR FIXED ORIFICE

FIGURE 8.1 FLOWRATOR ASSEMBLY COMPONENTS



CAUTION Use Piston sizes recommended by the outdoor unit manufacturer whenever possible. The piston should be sized according to the capacity of the outdoor unit.

WARNING Failure to install the proper piston can lead to poor system performance and possible compressor damage.

8.1.1. INSTALLATION OF PISTON / FIXED ORIFICE

NOTE: Photos are for basic illustration / reference purposes only. Actual equipment configuration may differ from that shown.



I-1. Disassemble the flowrator body using two wrenches. Unscrew the body with a counterclockwise motion.

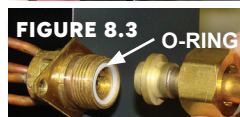

I-2. Replace the Teflon O-ring (located between the halves). Discard Schrader if present.

CAUTION Be aware of the Teflon O-ring. Be sure to replace the O-ring to attain a proper seal. (The Teflon O-ring is located between the two halves of the flowrator).

- I-3. Slide the attachment nut onto the liquid line stub out.
- I-4. Braze the stub-out portion to the liquid line and let cool.

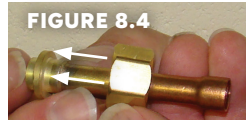

I-5. Taking care that the white Teflon seal is still in place inside the flowrator body, firmly seat the stub and screw the attachment nut to flowrator body.

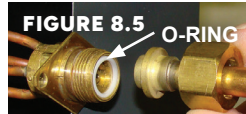

I-6. Tighten nut using no more than 10 ft-lbs of torque. A flare nut open end wrench is recommended to evenly distribute the force across all six sides of the nut to ensure piston body is not deformed.

8.1.2. PISTON REPLACEMENT

NOTE: Photos are for basic illustration / reference purposes only. Actual equipment configuration may differ from that shown.



During some installations, a piston change may be required. If so, the installer **MUST** change the piston. Use piston sizes recommended by the outdoor unit manufacturer. If a sizing chart is not available, use the piston size chart provided below to size the required piston. The size of the piston is stamped on the piston body (Fig 8.6).

FIGURE 8.6 II-1. Evacuate the system as per manufacturer guidelines and recommendations.

II-2. Turn the 13/16" nut once to release any residual pressure in the coil.

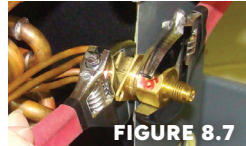

II-3. After ensuring that the coil is free of any residual pressure, disassemble the flowrator body completely using two wrenches. Take great care not to distort the feeder tubes. The wrench used to clasp the nut should be turned in counterclockwise direction to unscrew the nut.



II-4. Slide the 13/16" nut over the line-set and separate the two halves of the flowrator.



II-5. Pull the piston out using a small wire or pick. Verify the piston size (size is typically stamped on the body of the piston - Fig 8.6). If a different piston size is required by the outdoor unit manufacturer, re

place the piston using the small wire provided with the piston kit.



II-6. Replace the piston with one of the correct size. Do not force the new piston into the body. Make sure the piston moves freely in body.

CAUTION Pay close attention to the piston orientation. The pointed end of the piston **MUST** go into the distributor body, towards the coil. Failure to ensure this orientation will cause the piston to be bypassed during operation which might damage the outdoor unit.

II-7. Assemble the two halves correctly and ensure that the Teflon O-ring is present between the two halves (See I-5). Slide the 13/16" nut onto the distributor body.

CAUTION Be aware of the Teflon O-ring. Be sure to replace the O-ring to attain a proper seal. (The Teflon O-ring is located between the two halves of the flowrator).

II-8. Tighten the nut to a torque of approximately 10 ft-lbs. **Do NOT over-tighten the nut.** Over-tightening could crack the nut and/or impede the piston movement during operation.

II-9. If present, slide the rubber grommet back to position to prevent air leakage.

8.2 TXV COILS

WARNING The sensing bulb and TXV body **MUST** be protected from overheating during brazing. The sensing bulb and TXV body **must** be covered using a quench cloth or wet cloth when brazing. Pointing the brazing flame away from the valve and sensing bulb provide partial protection only.

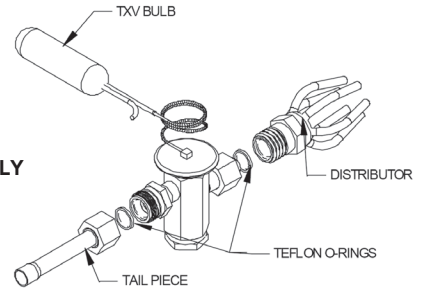

FIGURE 8.11
COMPONENTS OF A
TYPICAL TXV ASSEMBLY

WARNING Ensure that the TXV selected is compatible with the refrigerant used in the outdoor system. The TXV body is marked with R454B, or R32.

WARNING The valves should be sized according to the capacity of the outdoor unit. Failure to install the right valve can lead to poor performance and possible compressor damage.

I. TXV BULB HORIZONTAL MOUNTING

The orientation and location of the TXV bulb has a major influence on the system performance.

WARNING Ensure that the TXV bulb is in direct contact with the suction/vapor line. Gap between the bulb and tube should be avoided. Failure to do so will impair the proper functioning of the TXV valve.

It is recommended that the TXV bulb be installed parallel to the ground (on a horizontal plane). The bulb position should be at 2 o'clock or 10 o'clock. Fig. 8.12 shows the recommended position for the TXV bulb installation in the horizontal plane.

FIGURE 8.12
RECOMMENDED
LOCATION FOR
HORIZONTAL TXV
BULB MOUNT

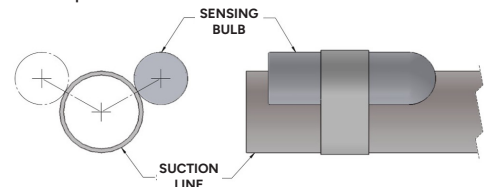

BULB POSITION AT 2 O'CLOCK OR 10 O'CLOCK

The TXV sensing bulb **SHOULD** be mounted on the suction line approximately 6" from the TXV or coil housing using the metal clamp provided. *In order to obtain a good temperature reading and correct superheat control, the TXV sensing bulb must conform to ALL of the following criteria:*

1. The sensing bulb **MUST** be in direct and continuous contact with the suction line.
2. The sensing bulb should be mounted horizontally on the suction line.
3. The sensing bulb **MUST** be mounted at the 2 o'clock or 10 o'clock position on the circumference of the suction line.
4. The sensing bulb **MUST** be insulated from outside air.

A properly mounted sensing bulb will prevent false readings caused by liquid refrigerant that may have formed inside the suction/vapor line. Insulation will protect the sensing bulb from false readings due to contact with warm air.

II. TXV BULB VERTICAL MOUNT

FIGURE 8.13
RECOMMENDED
LOCATION FOR
VERTICAL TXV
BULB MOUNT

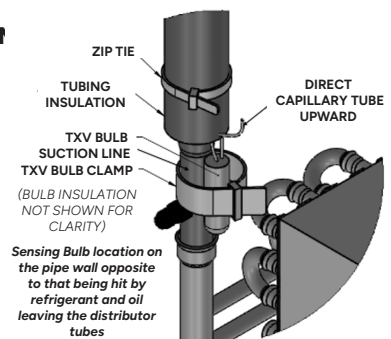

As recommended in Section 8.1, the TXV sensing bulb should be mounted in a horizontal plane in relation to the suction/vapor line. However, some installation configurations may require that the sensing bulb be mounted vertically. In this instance, place the bulb opposite the piping wall being hit by refrigerant and oil leaving the distributor tubes, and with capillary tubes directed upwards as shown in Fig. 8.13.

CAUTION If the TXV sensing bulb is mounted vertically; the capillary **MUST** be directed upwards. The bulb must be mounted on the wall opposite to that being directly hit by the refrigerant and oil leaving the distributor tubes.

III. FIELD-INSTALLED TXV RETROFIT

NOTE: Photos are for basic illustration / reference purposes only. Actual equipment configuration may differ from that shown.

WARNING Do not attempt to touch brazed joints while hot. Severe burns may result.

When installing an expansion valve, it is not necessary to slide the coil out of the housing.



III-1. Disassemble the Flowrator body using two wrenches. Unscrew the body with a counterclockwise motion.

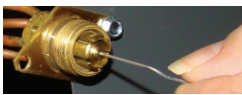

III-2. Remove the existing flowrator piston using a small wire or pick.



III-3. Replace the Teflon O-ring seal in place (located between the halves).

III-4. Inspect the TXV box to confirm that the valve is compatible with the refrigerant in the system.

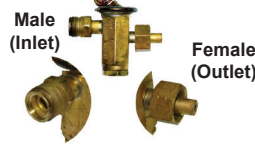

III-5. Remove the valve from the box and note the location of the inlet side (threaded male port) and the outlet side (female swivel nut port).

III-6. After ensuring that the Teflon O-ring seal is still in place inside the flowrator body, screw the female swivel nut onto the flowrator body.

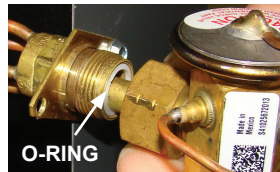

III-7. Slide attachment the nut onto the liquid line stub out. (See Section 8.1.1, I-3, Fig. 8.4)

III-8. Braze the stub-out portion to the liquid line and let cool.

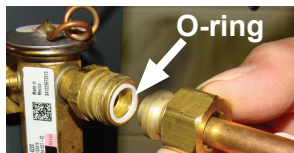

III-9. Remove the additional Teflon O-ring seal from the box and place on the shoulder just inside the TXV inlet port. Screw the nut attached to the stub-out portion of the flowrator body onto the inlet port of the TXV.

III-10. Tighten all connections taking care to use proper back up. Tighten the nut to a torque of approximately 10-30 ft-lbs

III-11. Remove the valve identification sticker from the valve and place it adjacent to the Aspen model number on unit name plate.



III-12. Some Aspen coils come with a Schrader valve on the suction line. If a Schrader port is present.

- A. Remove the valve stem from the Schrader port mounted on the suction line.
- B. Screw flare nut on TXV equalization tube onto the Schrader valve stem.

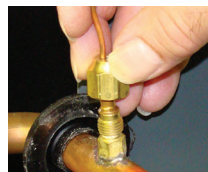

CAUTION When handling or manipulating the equalizer tube, take great care not to kink or make extreme bends in the tubing.

CAUTION Using a non-bleed expansion valve may require the use of a hard-start kit. Follow the outdoor unit manufacturer's guidelines.

9. LEAK CHECK / STANDING PRESSURE TEST / VACUUM TEST

9.1 STANDING PRESSURE TEST

1. Following outdoor unit manufacturer instructions and recommendations, Using dry nitrogen or dry helium, pressurize the field piping and indoor coil to the lower of the maximum operating pressures listed on the nameplates of the indoor and outdoor units (likely 600 psi).
2. The test pressure after removal of the pressure source shall be maintained for at least one (1) hour no decrease of pressure indicated by the test gauge, with the test gauge resolution not exceeding 30 psi.
3. Check for leaks by using a soapy solution at each field-made brazed joint and screw-on line connections. A leak will produce bubbles in the soap solution. No refrigerant shall be used for pressure testing to detect leaks.
4. If any leaks are discovered, remove nitrogen pressure and repair leaks. Repeat steps 1-3.

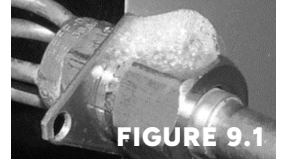

9.2 VACUUM TEST

Important: Do not open the service valves until the refrigerant lines and indoor coil leak check and evacuation are completed.

1. Evacuate until the micron gauge reads no higher than 350 microns, then close off the valve to the vacuum pump.
2. Observe the micron gauge. Evacuation is complete if the micron gauge does not rise above 500 microns in one (1) minute and 1500 microns in ten (10) minutes.
3. Once evacuation is complete, blank off the vacuum pump and micron gauge, and close the valve on the manifold gauge set.
4. All procedures for charging the system with refrigerant shall be according to the instructions provided by the manufacturer of the outdoor unit.

Important: Under no circumstances shall potential sources of ignition be used in the searching for or detection of refrigerant leaks.

After charging the system, all indoor field-made joints of the field piping shall be checked for refrigerant leaks using an electronic leak detector calibrated for R32 or R454B (depending on the application) having a sensitivity of 5 grams per year or better.

With no leaks or weak connections present, evacuate the system and charge as per the outdoor unit manufacturer instructions and specifications.

NOTICE Test pressures for A2L refrigerants, field made refrigerant joints shall have a sensitivity of 5 grams per year of refrigerant or at least 25 times the maximum allowable pressure. No leaks shall be detected in the systems.

10. ELECTRICAL LINE VOLTAGE CONNECTIONS

WARNING Disconnect ALL power before servicing or installing this unit. Multiple power sources may be present. Failure to do so may cause property damage, personal injury, or death.

WARNING Before obtaining access to terminals, all supply circuits must be disconnected.

WARNING A fused disconnect switch must be field provided for the unit to be in compliance with UL 60335-2-40 Clause 7.12.2.

These units are designed for single phase 120 volts, 60 HZ power supply. Wire selection and wiring must be in accordance with the latest edition of the National Electric Code, or in Canada the Canadian electrical Code, and local codes to determine correct wire sizing. Unit terminals are designed to accommodate copper and aluminum wiring. If aluminum wiring is used: All applicable local and national codes must be followed please observe special precautions relative to sizing, wire connections and corrosion protection.

Line voltage wiring should be routed through the access holes at the top of the air handler. To minimize air leakage, seal the wiring entry point



on the outside of the unit. Proper electrical conduit connection fittings should be used. Connect the power wiring to the line side connections on the air handler. The electrical ground wire should be connected to the grounding lug. Ensure both the field supplied ground wire and air handler GREEN ground wire are both secured to the grounding lug of the air handler.

11. LOW VOLTAGE CONNECTIONS

A 24 V power supply is provided by an internally wired low voltage transformer that is standard on all models. (See Fig 10.2). See the Wiring diagram, Fig. 17.5 & 17.6.

Connect the field wiring at the pigtailed supplied with the air handler as specified in Wiring diagram, Fig. 17.1, 17.2, 17.3 & 17.4. To minimize air leakage, seal the wiring entry point at the outside of the unit.

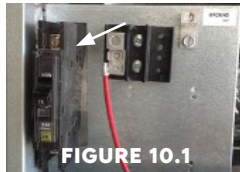

FIGURE 10.1



NOTICE

All wiring must comply with local and national electrical code requirements. Read and heed all unit caution labels.

11.1 SINGLE STAGE COOLING WITH ELECTRIC HEAT

The air handler comes factory setup for a single stage cooling system. The hydronic heat are pre-installed, and will also have a low voltage wire for field connection (Fig 11.1).

During cooling mode operation, the indoor blower G wire will energize a time delay relay inside the air handler. After a short time delay period, the time delay relay will send out a 24-volt signal to the low voltage terminal on the motor. Fan delay periods are 7 seconds ON delay and 65 seconds OFF delay. (See wiring in Section 17)

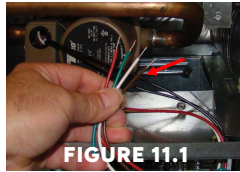

FIGURE 11.1

The Y wire from the thermostat is not connected at the air handler. This wire goes directly to the outdoor unit 24 volt wiring to turn on the outdoor condensing unit when a call for cooling takes place. The 24-volt common for the outdoor unit circuits is connected at the air handler Brown wire.

The hydronic heater low voltage wiring W terminal is wired directly from the thermostat to the air handler. The blower will delay on a heat call ON for a period of 5 seconds. The OFF-delay period is 60 seconds.

11.2 TWO STAGE CONDENSING UNITS

If the outdoor condensing unit is a two-stage model, a field provided Y2 wire can be connected to the motor using an electrical spade connector. The number 4 and 5 terminals on the motor are speed taps that will increase the blower speed for second stage cooling operation. Both the G and Y2 terminals will be energized at the same time during a call for second stage blower speed operation. The motor will run at the speed where the Y2 wire is connected (Fig 11.2).

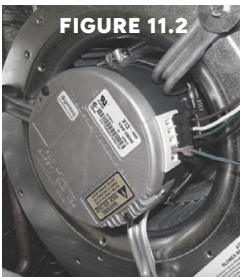

FIGURE 11.2

Operating CFM based upon each speed tap number is shown on the electrical wiring diagram of the unit. Final air volume adjustments should be made by referencing total external static pressure (Tables 12.2a and 12.2b below).

11.3 JUMPER PLACEMENT - CONTROL BOARD

The unit ships with a control board which controls the electrical functioning of the unit. An inspection of the controls is recommended prior to startup.

Fig.11-3 provides a schematic of the control board present in the unit. The unit ships from the factory with the aquastat jumper (AQ) in the OFF position (right two pins) and the heating selector in the HW position (right two pins). If an aquastat (AQ) is used in the application, the jumper should be changed to the ON position (left two pins). Terminals T and N located on the top right side of the board are not intended for field use and should be left disconnected.

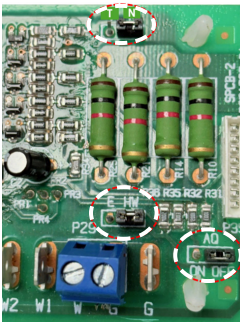

FIGURE 11.3

11.4 PUMP/BOILER/VALVE WIRING

Pump (Factory Installed): If a unit is equipped with the pump (Fig 11.4), it will be energized on a call for heat. Boiler (Field Install): For field install boiler, connect two wires on the "BOILER" terminals marked as T T (Fig 11.4a). See wiring diagram Fig 17 for proper connections.

In an application where a valve or pump is used to regulate the hot water supply, the two wires connected on the "BOILER" T T terminals should be removed and placed on the two terminals marked as "VALVE 24V" (Fig 11.4a). These wires should be connected to a 24V valve or pump relay according to local requirements and instructions of the valve or relay manufacturer.

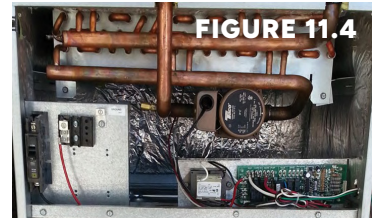

FIGURE 11.4

On a call for heat, 24V will be sent to the field-installed valve or pump relay, the valve will open or pump relay will close contacts allowing the pump to run. Water will circulate through the hydronic coil for 60 seconds prior to energizing the blower. After the thermostat is satisfied, the blower will continue to stay energized for a minimum of 30 seconds. The additional blower run time helps maximize heating efficiency.

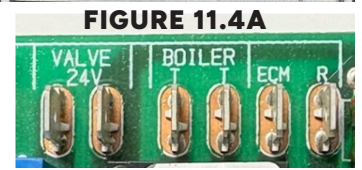

FIGURE 11.4A

11.5 FREEZE PROTECTION SENSOR WIRING

The freeze protection sensor is connected to the "FP" and "R" terminals (Fig 11.5). This sensor is normally open and will close when the sensor detects a temperature of less than 40°F. The pump will operate and stay ON for a minimum of 30 seconds.

The board has a built-in timer which circulates hot water 6 times a day for 60 seconds to prevent the hydronic coil from freezing.

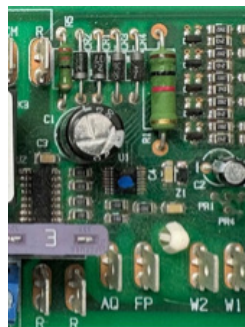

FIGURE 11.5

12. AIR VOLUME ADJUSTMENT

Air volume needs to be set to the level recommended by the outdoor unit equipment manufacturer. Most systems will require around 400 CFM of indoor air for every 1 ton of system cooling capacity. The air volume must be set prior to attempting system charge.

The HWCR*X Series uses a constant torque ECM Motor. This motor will try to maintain proper motor torque to achieve programmed air volume levels at varying levels of external static pressure. The air volume level produced by the air handlers at varying external static pressure levels is shown in Table 12.2a.

Use a Magnehelic Gauge with a 1" scale and two static pressure taps to measure the static pressure during the air volume adjustment procedure (Fig. 12.1). The high port static pressure tip should be placed in the supply duct near the outlet of the air handler. The low port static pressure tip should be placed in the return air duct near the entrance to the air handler. The factory provided air filter should be in place inside of the air handler.

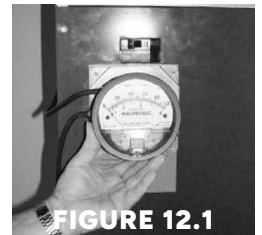

FIGURE 12.1

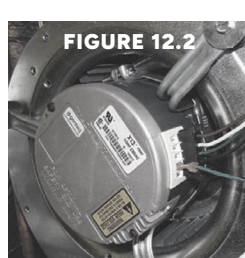

FIGURE 12.2

12.1.1.

Select a starting speed tap from the CFM table. The blower motor has selectable speed taps labeled 1 through 5 (Fig. 12.2). The speed taps are energized by 24 volts received from the time delay relay. When two stage cooling units are used, both the first and second stage fan speed taps will be energized at the same time. The motor will run at the speed generated at the highest motor speed tap.

12.1.2. Call for fan only operation at the thermostat.

12.1.3. Read the external static pressure level on the Magnehelic gauge.

12.1.4. Make speed tap selection changes to get the air volume as close as possible to the required level.

12.1.5. If the static pressure is above 0.5" w.c., excessive turbulence or duct friction needs to be reduced. (Obstructions in the duct system can also cause excessive static pressure.)

12.1.6. When proper air volume is established, move on to the charging procedure.

The HWCR*T Series uses a PSC type motor. The speed of this motor is set by placing the appropriate winding lead wire on the "MTR" terminal of the control board. Unused motor winding leads are to be placed on the "BLANK" terminals on the control board. The air volume level produced by the air handlers at varying external static pressure levels is shown in Table 12.2b.

TABLE 12.2A – HWCR*X AIRFLOW TABLE						
MODEL	SPEED TAP	CFM V EXTERNAL STATIC PRESSURE				
		0.1	0.2	0.3	0.4	0.5
24	T5	900	853	797	738	673
	T4	670	646	613	592	553
	T3	500	476	452	421	400
	T2	400	381	360	339	312
	T1	900	853	797	738	673
23	T5	895	860	815	770	705
	T4	825	795	770	750	700
	T3	770	735	705	685	665
	T2	705	675	655	615	595
	T1	655	615	605	580	540
30/36	T5	1150	1087	1030	975	910
	T4	1080	1048	1010	960	895
	T3	900	862	825	796	745
	T2	700	663	632	600	552
	T1	500	473	449	421	395
35	T5	1245	1190	1130	1085	1020
	T4	1170	1130	1085	1045	1000
	T3	935	910	865	840	805
	T2	815	785	745	715	685
	T1	685	655	605	580	520
42/48/60	T5	1850	1806	1752	1700	1652
	T4	1704	1656	1600	1532	1479
	T3	1494	1461	1426	1400	1364
	T2	1350	1310	1272	1229	1175
	T1	676	652	621	600	559
47/59	T5	1950	1880	1845	1805	1780
	T4	1765	1740	1725	1685	1660
	T3	1500	1480	1450	1415	1385
	T2	1245	1205	1185	1150	1105
	T1	1010	900	825	765	705

TABLE 12.2B – HWCR*T AIRFLOW TABLE						
MODEL	SPEED TAP	CFM V EXTERNAL STATIC PRESSURE				
		0.1	0.2	0.3	0.4	0.5
24	LOW	780	740	700	645	585
	HIGH	850	800	745	685	620
23	LOW	825	780	735	675	630
	HIGH	865	815	780	705	640
30/36	LOW	925	910	850	825	800
	MID	1180	1155	1115	1060	1000
	HIGH	1330	1270	1205	1140	1070
35	LOW	995	980	750	915	885
	MID	1140	1085	1045	1000	950
	HIGH	1220	1165	1130	1060	1000
42/48/60	LOW	1360	1340	1310	1280	1230
	MID	1530	1470	1420	1360	1310
	HIGH	1730	1670	1600	1540	1480
4759	LOW	1350	1315	1300	1245	1205
	MID	1500	1450	1400	1350	1315
	HIGH	1670	1615	1560	1515	1450

NOTE:

- Airflow data indicated is at 120V, front return, dry coil conditions only;

tested without filters, and without electric heat installed.

- Air handler units are tested to UL60335-2-40 standards up to 0.6 in. w.c. external static pressure.
- The above charts are for information only. For optimal performance, external static pressures of 0.2 in. w.c. to 0.5 in. w.c. are recommended. Heating applications are tested at 0.5 in. w.c. external static pressure. For satisfactory operation, external static pressure must not exceed value shown.
- Airflow data shown is from testing performed at 120V LGM units are equipped with a standard ECM constant torque motor.
- The above data can be used for airflow at other distribution voltages.

13. SYSTEM CHARGING

WARNING Units designed for use with R32 refrigerant **MUST** be charged with R32 refrigerant. Ensure that the R32 sensor is installed correctly and is operational.

WARNING Units designed for use with R454B refrigerant **MUST** be charged with R454B refrigerant. Ensure that the R454B sensor is installed correctly and is operational.

CAUTION An improperly charged system will likely cause loss in system performance and may damage the compressor.

CAUTION Refer to outdoor unit manufacturer charging guidelines and recommendations. The recommendations given below are general in nature and are NOT to supersede outdoor unit manufacturer specifications.

Where addition of charge is required to complete installation, instructions on how to determine the additional REFRIGERANT CHARGE and how to complete the REFRIGERANT CHARGE on the label provided by the outdoor unit manufacturer adjacent to the nameplate if the compressor bearing unit. Interconnecting refrigerant piping length and diameter shall be taken into consideration.

13.1. TXV COILS:

If the unit is equipped with a **fixed TXV**, add refrigerant until the subcooling measures at the outdoor unit liquid line matches the subcooling recommendations of the outdoor manufacturer. If the charge is unavailable charge the unit to a subcooling value of 8°F +/- 1°F.

If the unit is equipped with an **adjustable TXV**, add refrigerant until the subcooling measures at the outdoor unit liquid line matches the subcooling recommendations of the outdoor manufacturer. If the charge is unavailable charge the unit to a subcooling value of 8°F +/- 1°F.

NOTICE When adjusting the TXV, the valve stem or adjusting screw should not be adjusted more than a 1/4 turn at a time. To adjust superheat, turn the valve stem clockwise to increase and counterclockwise to decrease.

- 13.1.1.** If subcooling and superheat are low, adjust TXV to 8°F +/- 1°F superheat, then check subcooling.
- 13.1.2.** If subcooling is low and superheat is high, add charge to raise subcooling to 8°F +/- 1°F then check superheat.
- 13.1.3.** If subcooling and superheat are high, adjust TXV valve to 8°F +/- 1°F superheat, then check subcooling.
- 13.1.4.** If subcooling is high and superheat is low, adjust TXV valve to 8°F +/- 1°F superheat and remove charge to lower the subcooling to 8°F +/- 1°F.

The TXV should **NOT** be adjusted at light load / ambient conditions of 60°F or below.

13.2. FIXED ORIFICE / PISTON - FLOWRATOR COILS

Add refrigerant until the superheat measured at the outdoor unit suction/vapor line matches the superheat from the chart below.

OUTDOOR TEMP °F D.B.	SUPERHEAT		
	Min.	Nom.	Max.
65	30	35	40
70	26	30	34
75	21	25	29
80	17	20	23
85	12	15	18
90	8	10	12
95	4	5	7
100			

14. HYDRONIC HEAT

WARNING The hot water (hydronic) coil and all water lines **MUST** be purged of air prior to starting the pump. Failure to do so could result in pump damage. Aspen will not be responsible for any property or personnel damage caused by failure to follow this instruction.

WARNING Hot water flowing to the coil should be in the range of 120° - 180° F. Water at these temperatures can cause first-degree burns. Use of proper safety gear while installing or servicing the equipment is strongly recommended as installation of a water-tempering valve (for water temperatures of above 140°F) to supply lower temperature water to fixtures in the house. N170L series or equivalent should be used.

WARNING Installer **MUST** open water lines and run system to a.) ensure pump is primed and waterflow is constant and b.) ensure there are no leaks in the coils, connections, and/or water piping. Failure to do so could result in water leaks and property damage. Aspen will not be responsible for any damage caused by failure to follow this instruction.

NOTICE Plumbing must be in compliance with state or local codes (Code CMR248 in Massachusetts)

NOTICE Soldering Copper Tubing: The common method of joining copper tubing in hydronic heating systems is soft soldering. Plumbing codes do not allow solders containing lead to be used for domestic water service.

WARNING **USE NO-LEAD SOLDER** for all piping systems that incorporate a domestic water supply.

Connect the hydronic coil to the water heater system by using flexible piping. Connect the hot water to "IN" from the water heater discharge and from the hydronic coil discharge water "OUT" back to water heater inlet as shown in Fig 14.1a. and Fig 14.1b.

7/8" OD copper stubs are provided for plumbing connections. Bleed the air from the system through the bleeder port or optional valve and insulate all the pipes.

The hydronic heat air handler units have different top and heater box configurations. This configuration is not suitable for electric heat. **DO NOT** try to install a hydronic heater in a unit not equipped for it.

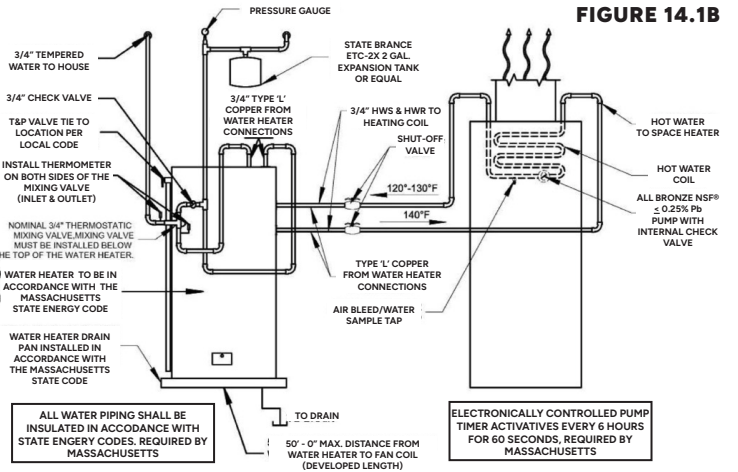
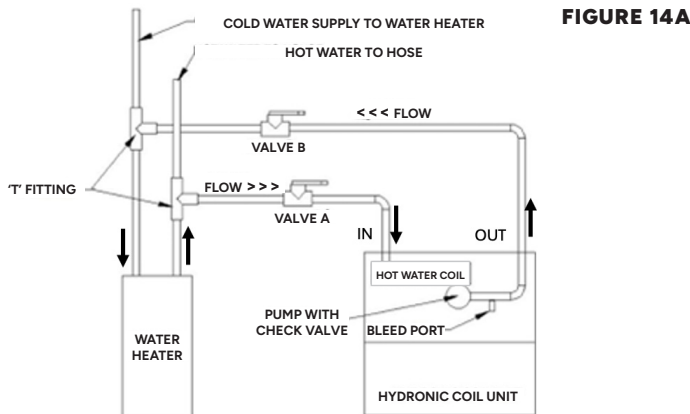

14.2. PURGING THE SYSTEM

1. Open air vent and allow water heater to fill with water. Close the air vent when the water heater is full, and all air has been purged.
2. Ignite water heater. Set the thermostat on the water heater to 140° degrees.
3. Close the valve on the hot water supply from the water heater ("A") and open the valve on the cold water return to the water heater ("B"). Then open the air vent in the fan coil. Use bucket or hose to discard water during purging process at air bleed valve. Purge air completely from the line.
4. Once air is purged, close return valve ("B") and open supply valve ("A"). Purge the coil and lines of air completely.
5. After air is purged from the system and filled with water, open the return valve ("B"). Then close the air vent in the fan coil.
6. Apply power to the fan coil and set the room thermostat on heat. Raise the temperature setting to activate the circulating pump.
7. Check the pump to ensure proper operation. The water inlet of the unit should be hot if the water temperature in the water heater has reached the set point. If water is not being circulated through the coil but the pump is running, then open the air bleed valve in the unit and purge any air left in the system.
8. Adjust the water heater thermostat so that the water temperature entering the hot water coils is 120 – 180°F depending on the amount of heat required by the structure. This is done with the unit energized and operating long enough for all temperatures to stabilize.

14.3 HEAT ANTICIPATOR ADJUSTMENTS

After all connections are made, start-up and check-out must be performed before proper evaluation of the entire system can be made. Make sure that the heat anticipator is properly set as noted on thermostat instructions.

Load requirements can vary in each residence, and it may be necessary for the installer or homeowner to make slight adjustments to the heat anticipator setting for longer or shorter cycles. It is recommended to change the setting to no more than plus or minus 0.05 amps at a time. Greater changes can cause the unit to rapid cycle or remain on excessively.

To properly check the unit's operation, the installer should have an electrical current measuring device (0-10 amp, Amprobe Fluke), air pressure measuring device (0-1.0 inch slope gauge), and a temperature-measuring device (0-200°F thermometer).

Install the Amprobe to measure blower current, the slope gauge to measure static air pressure at the units and the temperature device to measure unit supply and return air temperature. Before taking measurements, be sure that all registers, grilles and dampers are open or are set to their proper positions. Be sure that clean filters are in place. Temperature measuring device must be installed to obtain average temperature at both inlet and outlet. For outlet, measure temperature of each main trunk at a location far enough away to avoid heater radiation and read the average temperatures. Airflow Table 12.2a for HWCR*X and Table 12.2b for HWCR*T shows the CFM that should be achieved at various external static pressures.

14.4 CHECKING AIR FLOW/TEMPERATURE RISE METHOD

Turn on the power supply. Set thermostat fan switch to on. Set the cooling

indicator to maximum, heating to minimum. The system switch may be on heat or cool. Check slope gauge measurement against appropriate air flow chart. Make damper, register and motor speed adjustments to obtain required airflow.

Set thermostat fan switch to auto, system to heat and thermostat heating indicator to maximum heat. Blower should start and all heat be energized.

Check air flow using temperature rise method formula:

$$CFM = \frac{OUTPUT(BTUH)}{1.08 \cdot TEMP.RISE}$$

Note: BTUH output should be computed by 500 x Gallons Per Minute x System Temperature Change = BTUH OUTPUT.

14.5 HYDRONIC RELATED GENERAL INFO.

14.5.1 Equipment Sizing: Select an air handler with a heating output that exceeds the space heating loss of the structure and that has a cooling coil sized to match the outdoor condensing unit.

Note: The heating output of the air handler or hot water coil will not be greater than the output of the selected hot water heater. Therefore, if the water heater is undersized the heating BTUH of the air handler will be LESS than its rated output.

14.5.2 Water Heater Selection: The following sizing information should only be used as a basic guide to adequate water heater sizing because of variations in each family's domestic hot water requirements. For additional assistance in water heater sizing contact a professional engineer. Proper water heater sizing should consider both the gallon capacity and the BTU input of the water heater.

• **To determine water heater GALLON CAPACITY:**

A minimum 40-gallon high recovery and/or high efficiency gas or oil-fired water heater is recommended. The following volume-sizing guide is satisfactory in most areas of the country, see Table 14.5.2

CFM	Min Water Heater
600-800	40 gal
1000-1200	50 gal
1400-1600	2x40 gallons piped together
	High input 50 gallons (63-75k Btu)
2000	72-75gallons
	105k Btu

FIGURE 14.5.2

• **To determine water heater BTU INPUT (assumes a water heater recovery efficiency of 76%):**

- For mild climates: BTU INPUT = structure's heat loss x 1.51.
- For colder climates: BTU INPUT = structure's heat loss x 1.58

14.5.3 Pump Replacement:

1. Disconnect electrical power to the unit before servicing.
2. Remove access door to reveal pump. Close supply valve ("A") and return valve ("B"). Open the air bleed valve to release pressurize in the system and drain water.
3. Remove the metal pump housing by loosening the four screws on the pump. Note: **DO NOT UN-SOLDER PUMP.**
4. Replace the new pump housing assembly and reconnect components to the pump. Before you assemble, make sure that the runner on the o-ring is in place on the pump housing.
5. Purge the system of the air as described earlier and re-connect the electrical power.





14.5.3 Trouble Shooting:

- Noisy Pump: System may not be totally purged of air. Purge the system again as described in the start-up section above.
- T&P valve on water heater weeps: This normally occurs when a back-flow preventer has been installed in the cold water supply line to the water heater. An expansion tank may be necessary to correct this problem. Please contact a qualified plumbing professional for assistance.
- Hot water is circulating through the water coil during cooling cycle: The check valve may be stuck open and allowing hot water to circulate

through the coil.

- Little or no heat from water coil:
 - o Purge the system.
 - o The inlet connections may be reversed at the fan coil.
 - o The water heater thermostat is not set at proper temp.
 - o The water heater thermostat is not calibrated.
 - o The dip tube in the water heater may not be installed correctly or could be restricted.
 - o Look for restrictions in heating system from water heater to fan coil. Some water heaters are supplied with check valves, remove any extra check valves except for the one supplied with the fan coil.
 - o The air handler is undersized for space being heated.
 - o The water heater is undersized.

15. A2L REFRIGERANT LEAK DETECTION SYSTEMS

-  Read the precautions in this manual carefully before operating the unit.
-  Read the instructions in this manual carefully before operating the unit.
-  Read the instructions in this manual carefully before servicing the unit.
-  Read the instructions in this manual carefully before wiring the unit.
-  Warning or Caution

Products designed for use with A2L Refrigerants are equipped with a refrigerant leak detection system (which includes an A2L Sensor, a Mitigation Control Board, Accessory Control Relay, and Harnesses) which must be wired as specified in the Wiring Diagram.

The A2L Sensor must be installed and powered for service.

 **WARNING** Disconnect ALL power before servicing or installing this unit. Multiple power sources may be present. Failure to do so may cause property damage, personal injury, or death.

 **WARNING** When using FLAMMABLE REFRIGERANTS, LEAK DETECTION SYSTEM installed. Unit must be powered except for service.

15.1. RDS: SENSOR, MITIGATION CONTROL, AND WIRING

Refer to Table 15.1 for R32 and Table 15.2 for R454B below for minimum conditioned room requirements.

Wiring instructions are detailed in the wiring diagrams in Section 16 of this manual. All wiring installed in the field used with the RDS must meet the following specifications:

- 18 AWG
- 1.58mm insulation thickness or protected from damage

The RDS is field installed. The sensor location is shown in Figure 15.1.

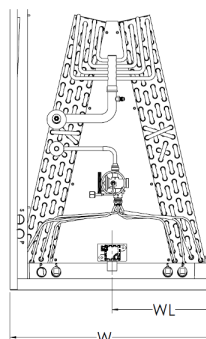

FIGURE 15

WIDTH (W)"	SENSOR LOCATION (WL)"
14.5	7.25
17.5	8.75
21.0	10.50
24.5	12.25

It is the installer's responsibility to ensure that mitigation mode is operational. The functionality can be tested after the installation.

The A2L sensor is not intended for service or repair. If the sensor is not functioning properly, mitigation mode will engage and the sensor must be replaced by removing the sensor and sensor clip assembly from the drain pan and replacing with a new sensor and sensor clip assembly.



WARNING Refrigerant sensors for refrigerant detection systems shall only be replaced with sensors specified by the appliance manufacture.

TABLE 15.1

Minimum Mitigation Airflow for R32 Systems						
Total System Charge (lb)	Total System Charge (oz)	Total System Charge (kg)	Minimum Room Area (m ²)	Minimum Room Area (ft ²)	Minimum Mitigation Airflow (m ³ /hr)	Minimum Mitigation Airflow (CFM)
4	64	1.81	5.39	58.02	177.88	105
5	80	2.27	6.74	72.53	222.35	131
6	96	2.72	8.09	87.03	266.82	157
7	112	3.18	9.43	101.54	311.29	183
8	128	3.63	10.78	116.04	355.76	209
9	144	4.08	12.13	130.55	400.23	236
10	160	4.54	13.48	145.05	444.70	262
11	176	4.99	14.82	159.56	489.17	288
12	192	5.44	16.17	174.06	533.64	314
13	208	5.90	17.52	188.57	578.11	340
14	224	6.35	18.87	203.07	622.58	366
15	240	6.80	20.21	217.58	667.05	393
16	256	7.26	21.56	232.08	711.52	419
17	272	7.71	22.91	246.59	755.99	445
18	288	8.16	24.26	261.09	800.46	471
19	304	8.62	25.60	275.60	844.93	497
20	320	9.07	26.95	290.10	889.40	523

NOTE: The installer should verify the actuation of the mitigation procedure, as well as the the airflow according to the chart. The installer should refer to the airflow table provided by the furnace or blower manufacturer.

TABLE 15.2

Minimum Mitigation Airflow for R454B Systems						
Total System Charge (lb)	Total System Charge (oz)	Total System Charge (kg)	Minimum Room Area (m ²)	Minimum Room Area (ft ²)	Minimum Mitigation Airflow (m ³ /hr)	Minimum Mitigation Airflow (CFM)
4	64	1.81	5.57	59.98	183.89	108
5	80	2.27	6.97	74.98	229.86	135
6	96	2.72	8.36	89.97	275.83	162
7	112	3.18	9.75	104.97	321.81	189
8	128	3.63	11.14	119.96	367.78	216
9	144	4.08	12.54	134.96	413.75	244
10	160	4.54	13.93	149.95	459.72	271
11	176	4.99	15.32	164.95	505.69	298
12	192	5.44	16.72	179.94	551.67	325
13	208	5.90	18.11	194.94	597.64	352
14	224	6.35	19.50	209.93	643.61	379
15	240	6.80	20.90	224.93	689.58	406
16	256	7.26	22.29	239.92	735.55	433
17	272	7.71	23.68	254.92	781.53	460
18	288	8.16	25.08	269.92	827.50	487
19	304	8.62	26.47	284.91	873.47	514
20	320	9.07	27.86	299.91	919.44	541

NOTE: The installer should verify the actuation of the mitigation procedure, as well as the the airflow according to the chart. The installer should refer to the airflow table provided by the furnace or blower manufacturer.

NOTE: The Total System Charge in the above tables, 15.1 and 15.2 is the total system charge which is marked on the system as specified in the outdoor unit manufacturer's instructions.

HEIGHT / Altitude (m)	HEIGHT / Altitude (ft)	ALTITUDE ADJUSTMENT FACTOR
0	0	1.00
200	656	1.00
400	1312	1.00
600	1969	1.00
800	2625	1.02
1000	3281	1.05
1200	3937	1.07
1400	4593	1.10
1600	5249	1.12
1800	5906	1.15
2000	6562	1.18
2200	7218	1.21
2400	7874	1.25
2600	8530	1.28
2800	9186	1.32
3000	9843	1.36
3200	10499	1.40

The mitigation requirements for evaporator coils using A2L refrigerants are calculated at sea level. For altitudes above 800 meters, the minimum conditioned area must be adjusted by the corresponding altitude adjustment factor (AF) shown in the reference table below.

The Mitigation Control Board provides refrigerant leak detection and mitigation response for systems utilizing A2L-type refrigerants. The Mitigation Control Board can monitor up to two A2L Sensors, depending on the system's needs. The control module will constantly monitor the A2L Sensor(s) for a refrigerant leak condition. **When the A2L Sensor detects a concentration of**

refrigerant which meets or exceeds the Lower Flammability Limit (%LFL), the control module locks out the compressor and activates the ventilating fan.

The Mitigation Control Board control module is certified as a Class B safety control and conforms to the guidelines set forth in Annex LL of UL standard 60335-2-40:

- The control will communicate with an external A2L Sensor in order to request data on the concentration of airborne refrigerant within the system enclosure.
- The control will provide a system response (i.e. deactivate the compressor, energize a ventilating fan, and provide an alarm indication) in the event of a reported concentration of at least 15% of the Lower Flammability Limit (determined by refrigerant composition). The system response (also referred to as the "mitigation state" or "safe state") must last for at least 5 minutes from initial fault detection.
- The control will only be able to recover operation if the system response has been active for at least 5 minutes and the A2L Sensor reports a concentration of refrigerant less than 8% LFL.
- Loss of communication between the control and the A2L Sensor will also result in the mitigation state for at least 5 minutes. The control will not recover until communication is restored.

15.2 RDS: A2L MITIGATION+ACCESSORY CONTROL VERIFICATION

VERIFICATION: RUNNING THE SYSTEM TEST IS MANDATORY FOR ALL INSTALLATIONS. THE HVAC SYSTEM MUST NOT COMPLETE COMMISSIONING UNTIL THE INSTALLATION STEPS OUTLINED IN THIS MANUAL HAVE BEEN SUCCESSFULLY COMPLETED.

IMPORTANT: NEVER CONNECT SENSOR TO THE MITIGATION CONTROL BOARD WHILE IT IS POWERED UP. ONLY USE THE "SENSOR1" PORT, THE "SENSOR2" PORT SHALL ONLY BE USED IN APPLICATIONS WITH TWO INDOOR UNITS IN WHICH THE SENSOR FROM THE SECOND INDOOR UNIT WILL ALSO CONNECT TO THE MITIGATION CONTROL BOARD. ALWAYS ENSURE THAT THE SYSTEM IS POWERED OFF BEFORE CONNECTING THE SENSOR TO THE MITIGATION CONTROL BOARD. IF THE SENSOR IS NOT CONNECTED BEFORE POWERING UP, THE SYSTEM WILL ENTER LEAK MITIGATION MODE. ONCE THE SYSTEM ENTERS LEAK MITIGATION MODE IT WILL STAY IN MITIGATION STATE FOR AT LEAST 5 MINUTES. THEREFORE, IT IS STRONGLY ADVISED TO CONNECT THE SENSOR BEFORE POWERING UP.

Perform the A2L Mitigation Control refrigerant leakage test for all modes of operation one by one. – Cooling (for ACs & heat pumps), Heating (for heat pumps), Electric Heating, and Fan modes.

The "Accessory Control" includes a relay and a wire harness used to de-energize the W1 & W2 call or to energize or de-energize add on equipment / accessories or functions.

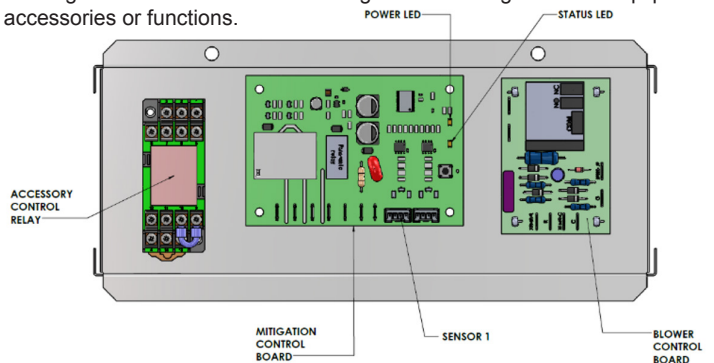

FIGURE 15.2

Set the thermostat to one of the above operation modes, and ensure that the system is powered and running properly in that mode. The test sequence will need to be performed again in each operation mode. Remove the access panel from the unit to access the mitigation control board and accessory control relay. Once the system is powered, the control will communicate with the A2L sensor to request data on the concentration of airborne refrigerant within the coil cabinet, wait 10 seconds, and verify that the STATUS LED shows Warm-Up mode (solid ON), then wait 20 – 30 seconds and verify that the STATUS LED shows Run mode (solid OFF).

- A. Locate the sensor cable connected to the "SENSOR1" port on the mitigation control board. (See Figure 15.3). Remove the sensor cable by squeezing the tab on the connector and pulling away from the board to disconnect the sensor.
- B. Once the sensor is disconnected, wait 15 seconds, the mitigation control board no longer detects the sensor, verify that the STATUS LED blinks fault code for communication fault (2 blinks), the mitigation sequence begins:
 - i. The HVAC system operation that was chosen the control will provide a system response which will deactivate the compressor and the additional equipment / accessory that is connected to the terminals 3, 4 and 11, 12 of the relay such as but not limited to electric heat or gas heat or air cleaner at the same time, then it will energize the indoor blower. See the relay and wiring diagram below for details.
 - ii. The indoor blower will begin to operate and remain running for at least 5 minutes from initial fault detection. The STATUS LED (2 blink) fault code will continue for the entire 5 minutes.
 - iii. Once steps B. i., and B. ii. have been confirmed the test is considered successful. It is recommended to wait the entire 5 minutes to allow the test sequence to expire.

- 16.1.2.** With cooling system operating, check for condensate leakage.
- 16.1.3.** Perform leak detection inspection of refrigerant circuit and connecting piping.
- 16.1.4.** Secure all cabinet doors. All panels must be in place and secured. For airtight application, all gaskets must remain intact on all surfaces as shipped with the unit at prescribed locations to achieve 1.4% low leakage.

NOTE: Loss of communication between the control and the sensor will also result in the mitigation state for at least 5 minutes. The control will not recover until communication is restored.

15.3. MITIGATION CONTROL BOARD OPERATION

15.3.1 OPERATION

MITIGATION CONTROL OPERATION			
Current State	Outputs	Status Indication	Next state
Sensor Warm-up	CC: Off Fan: Off Alarm: On	ON	<ul style="list-style-type: none"> • If sensor reports Run mode: Normal Operation • If sensor reports Error mode: Communication Fault
Normal operation	CC: On Fan: Off Alarm: On	OFF	<ul style="list-style-type: none"> • If %LFL > Trip point: % LFL Fault • If board loses communication with sensor: Communication Fault
Communication Fault	CC: Off Fan: On Alarm: Off	2 BUNKS	<ul style="list-style-type: none"> • If board receives valid data on required sensor port(s) and lockout timer expires: Normal operation
%LFL Fault	CC: Off Fan: On Alarm: Off	1 BUNK	<ul style="list-style-type: none"> • If %LFL < Recovery point and lockout timer expires: Normal operation

LED STATUS CODES

LED Code	Number of Pulses
Normal Operation	100% OFF
Warm-up	100% ON
%LFL Fault	1
Communication Fault	2

15.3.2 APPLICATION-SPECIFIC PARAMETERS

- %LFL Trip Point - (15%): The concentration of sensed refrigerant that will cause a fault condition, expressed as a percentage of the LFL (25% is the maximum allowable value per UL standard). Also referred to as the DTLV.
- %LFL Recovery Point - (8%): The concentration that the sensed refrigerant must be less than in order to recover from a fault condition, expressed as a percentage of the LFL. The recovery point cannot exceed the trip point.
- Lockout Time - (300) The minimum amount of time (in seconds) that must elapse before the control can recover from a fault after entering the mitigation state (300 is the minimum allowable value per UL standards).
- Reset Mode - (Auto): The method of fault recovery for the control.

NOTE: Loss of communication between the control and the sensor will also result in the mitigation state for at least 5 minutes. The control will not recover until communication is restored.

16. FINAL SYSTEM CHECKOUT

- 16.1.1.** Make certain all cabinet openings are properly sealed, and any grommets moved during installation are moved into proper place.

17. WIRING DIAGRAMS

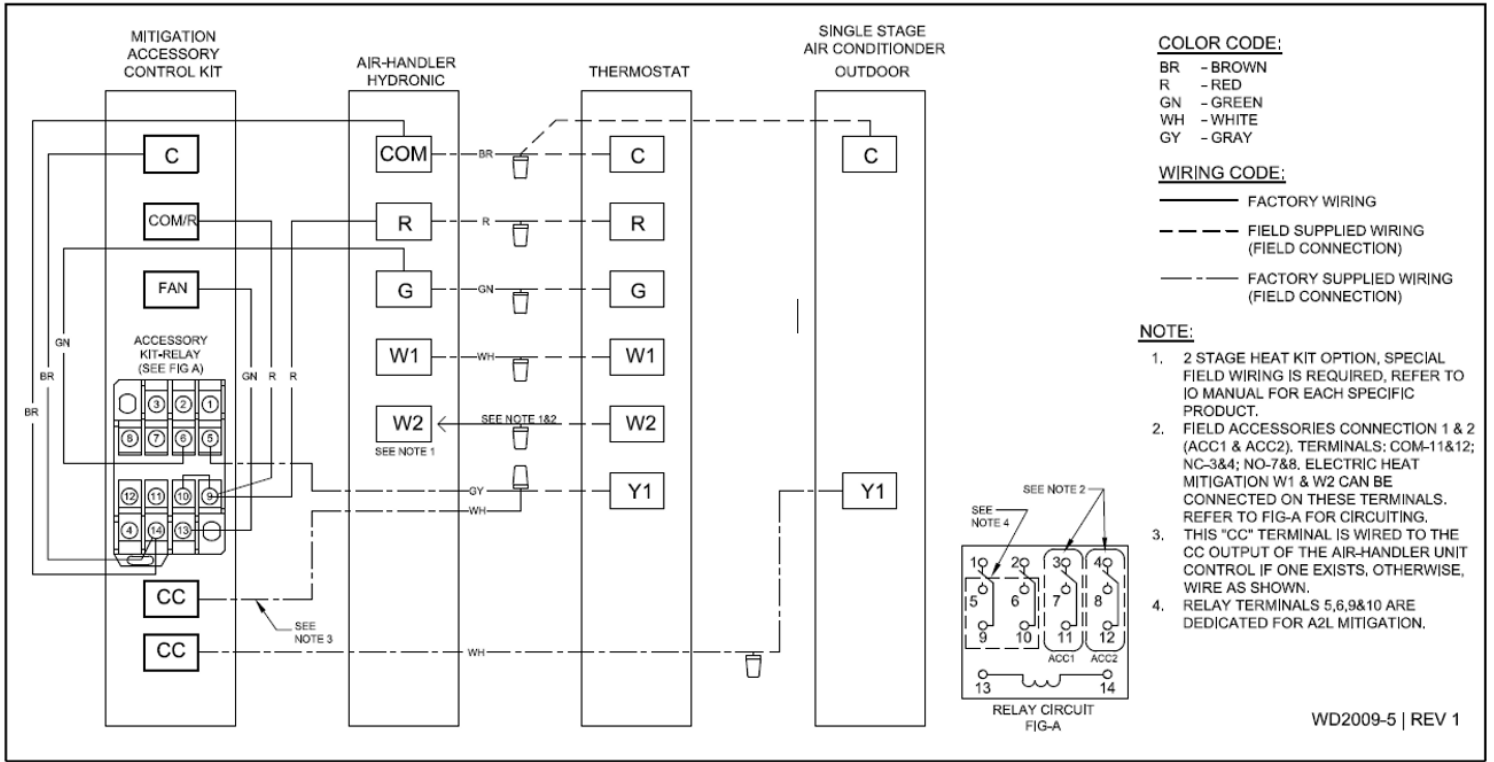

FIGURE 17.1 – SINGLE-STAGE AC

NOTE: Wiring Diagram is subject to change. Always refer to the wiring diagram on the unit for the most up-to-date wiring.

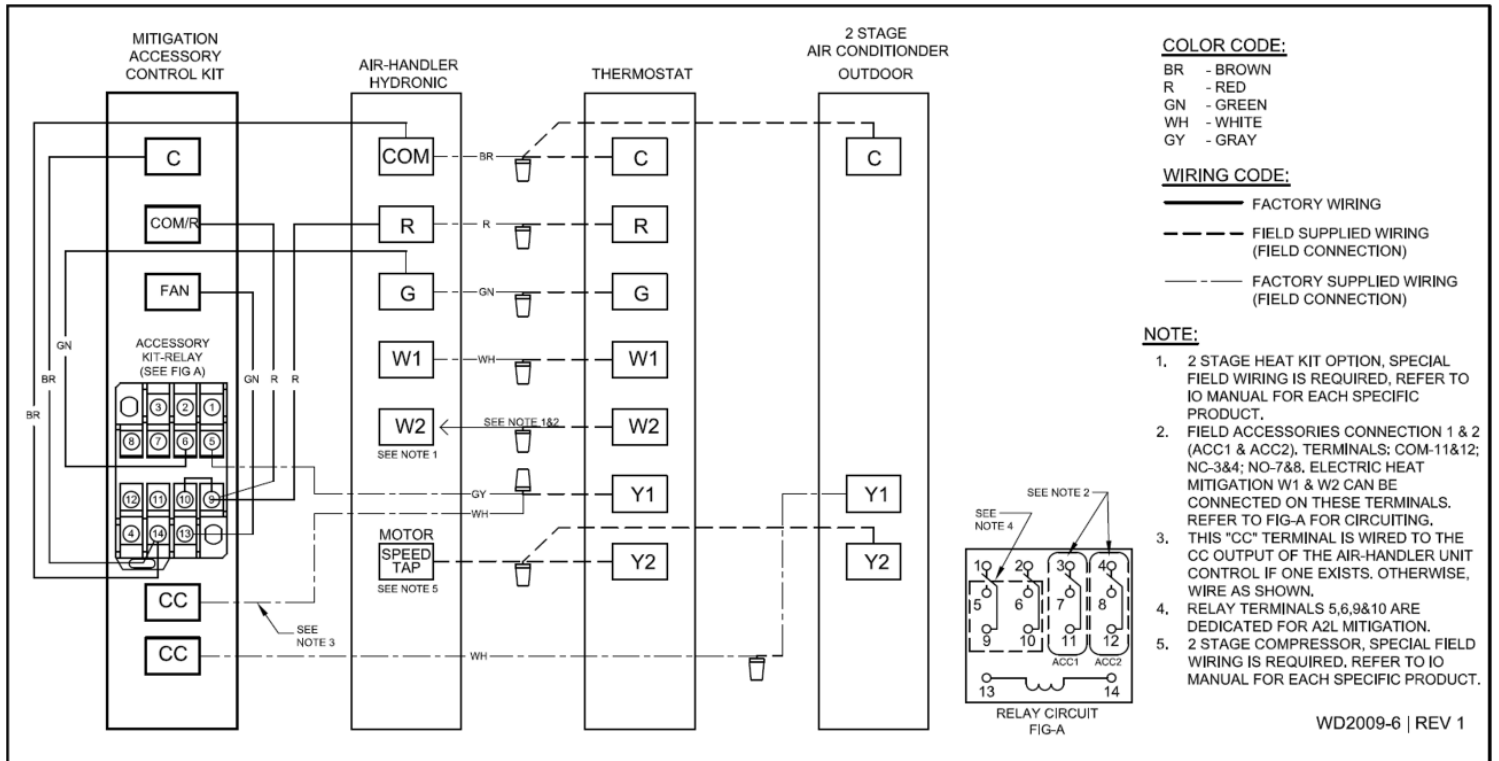

FIGURE 17.2 – MULTI-STAGE AC

NOTE: Wiring Diagram is subject to change. Always refer to the wiring diagram on the unit for the most up-to-date wiring.

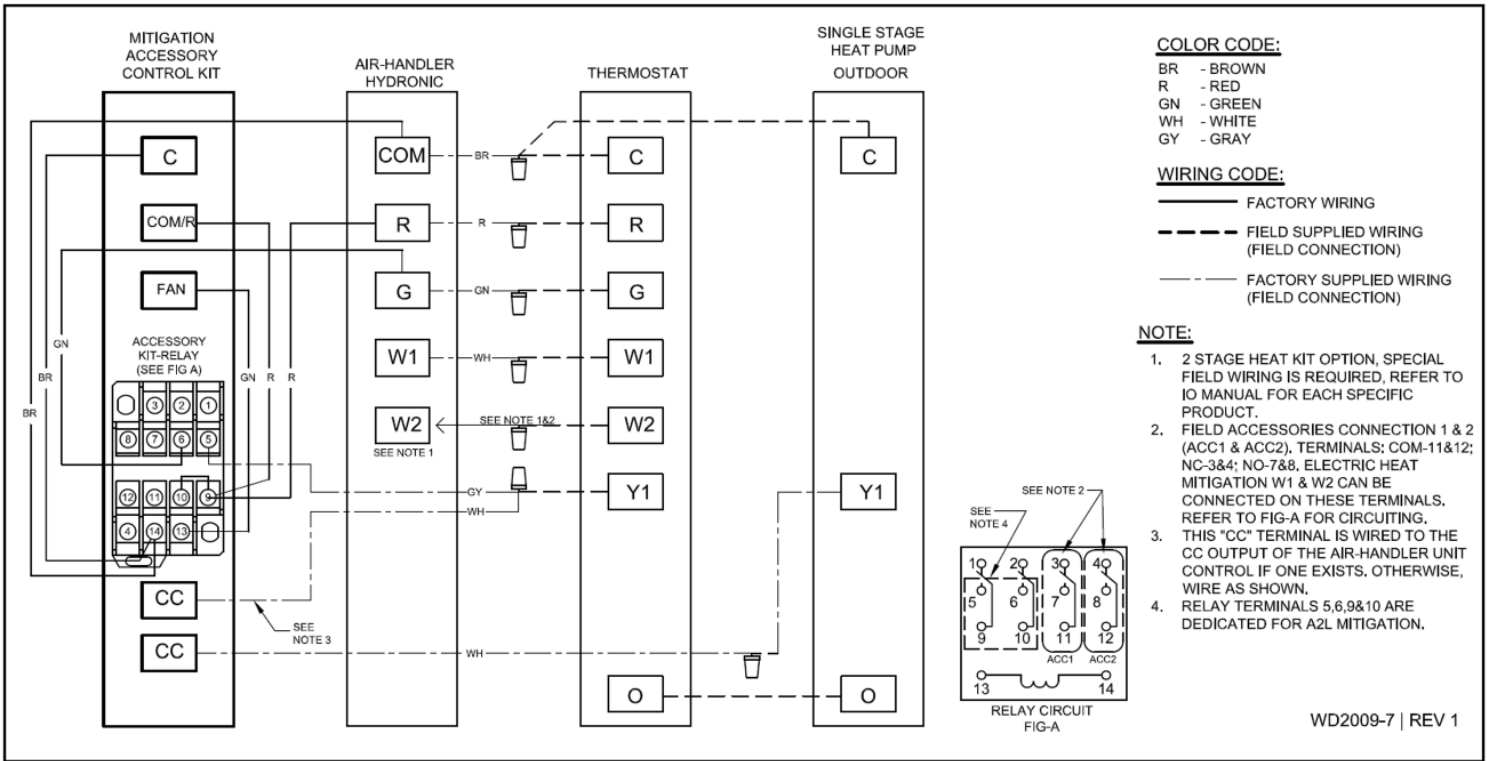

FIGURE 17.3 – SINGLE-STAGE HEAT PUMP

NOTE: Wiring Diagram is subject to change. Always refer to the wiring diagram on the unit for the most up-to-date wiring.

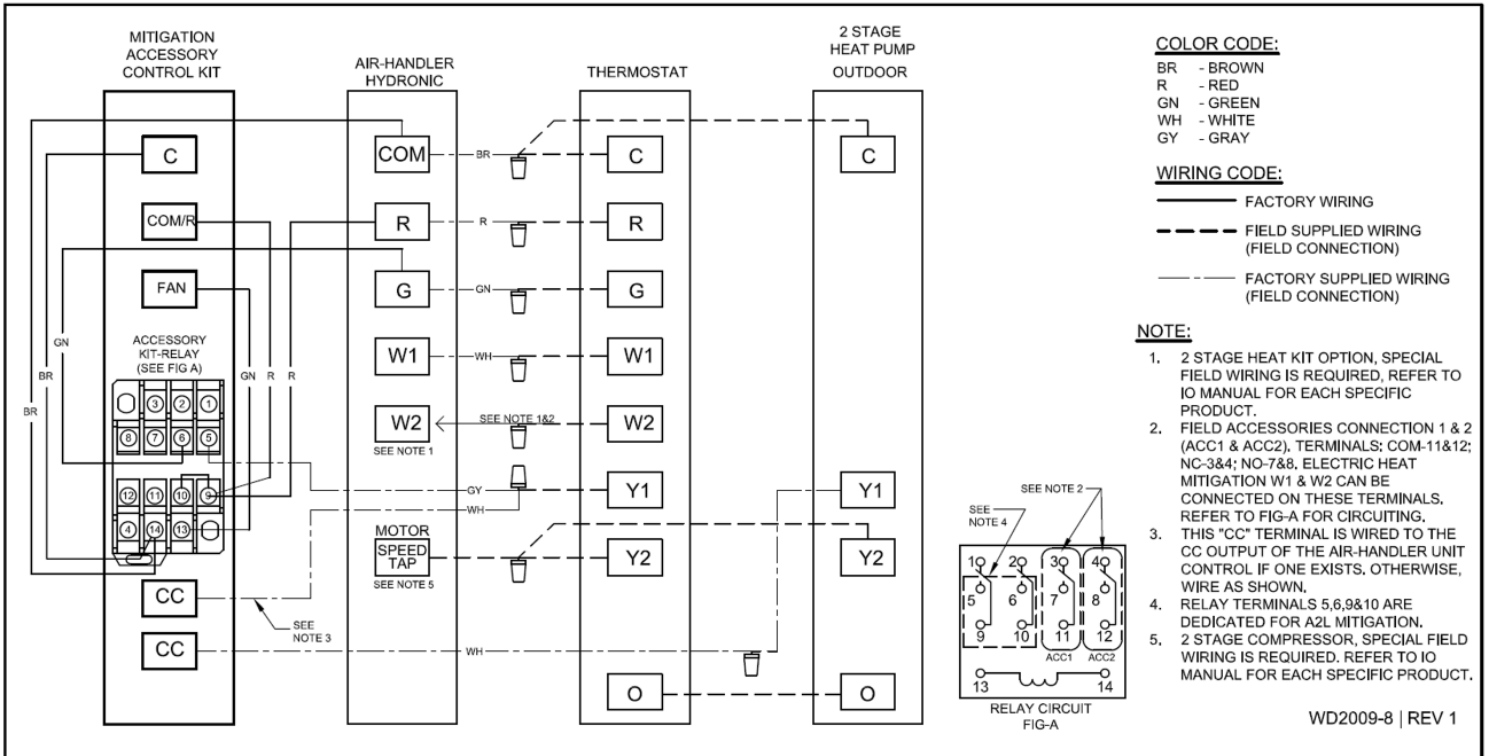

FIGURE 17.4 – MULTI-STAGE HEAT PUMP

NOTE: Wiring Diagram is subject to change. Always refer to the wiring diagram on the unit for the most up-to-date wiring.

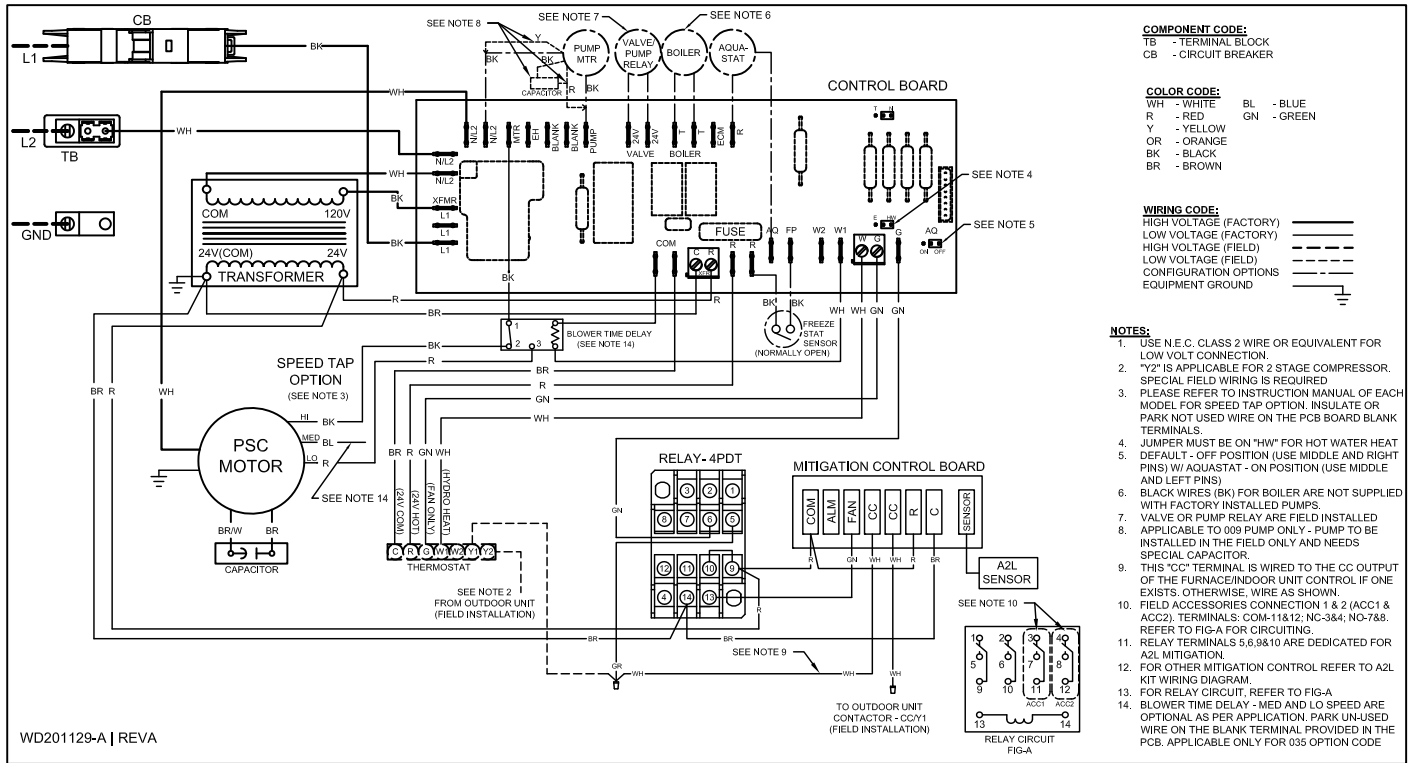

FIGURE 17.5 – ECM MOTOR

NOTE: Wiring Diagram is subject to change. Always refer to the wiring diagram on the unit for the most up-to-date wiring.

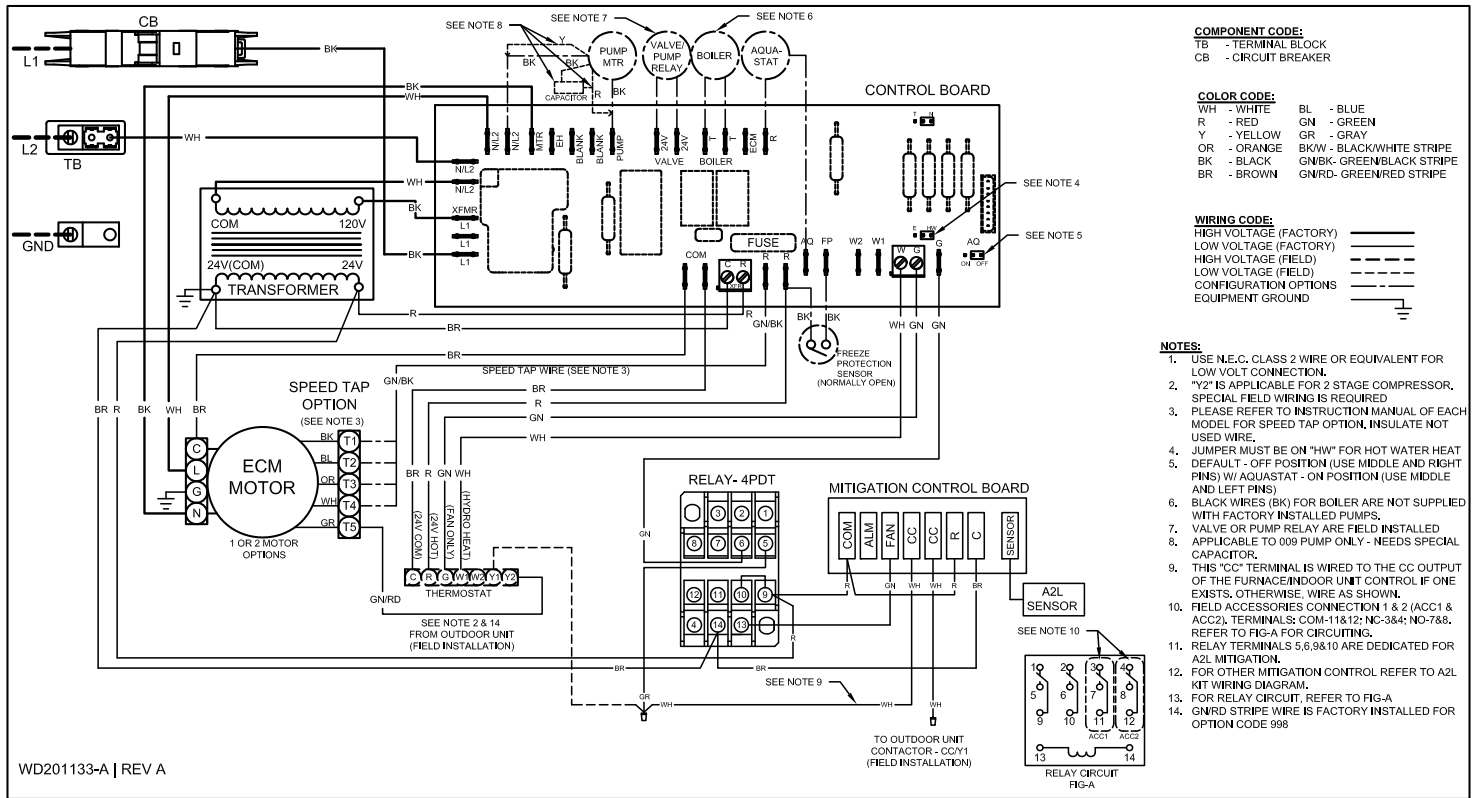

FIGURE 17.5 – ECM MOTOR

NOTE: Wiring Diagram is subject to change. Always refer to the wiring diagram on the unit for the most up-to-date wiring.



LIMITED EXPRESS WARRANTY - HWCR AIR HANDLERS

Congratulations on purchasing your new HVAC equipment. It has been designed for long life and reliable service, and is backed by one of the strongest warranties in the industry. Your unit automatically qualifies for the warranty coverage listed below, provided you keep your proof of purchase (receipt) for the equipment and meet the warranty conditions.

LIMITED SIX (6) YEAR PARTS EXPRESS WARRANTY

All parts are warranted to be free from defects in workmanship and materials for normal residential use and maintenance for six (6) years from the date of purchase by the original consumer for the original residential installation, when the air handler is installed in a non-AHRI matched system. This Limited Express Warranty applies only when the air handler is installed per Comfort-Aire/Century installation instructions and in accordance with all local, state and national codes for normal residential use.

MATCHED SYSTEM LIMITED EXPRESS WARRANTY

When the air handler is installed as part of a residential AHRI-matched system with a Comfort-Aire/Century air conditioning condenser or heat pump, the condenser or heat pump warranty applies to the air handler under normal use and maintenance. Refer to the condenser or heat pump warranty for details, and register the product within 60 days of the purchase for the AHRI-matched system warranty.

EXCEPTIONS

The Limited Express Warranty does not cover normal maintenance— Comfort-Aire/Century recommends that regular inspection/maintenance be performed according to the Installation/Operation/Maintenance Manual. Additionally, labor charges, transportation charges for replacement parts, replacement of refrigerant or filters, any other service calls/repairs are not covered by this Limited Express Warranty. It also does not cover any portion or component of the system that is not supplied by Comfort-Aire/Century, regardless of the cause of failure of such portion or component. Purchasers in Florida, California, Quebec, and any other jurisdiction that prohibits registration requirements to effectuate warranties (1) have no registration requirement and automatically receive the default extended warranty applicable to your equipment, if any, and (2) the failure to register your equipment does not diminish your warranty coverage.

CONDITIONS FOR WARRANTY COVERAGE

- Unit must be operated according to the Comfort-Aire/Century operating instructions included with the unit and cannot have been subjected to accident, neglect or misuse, alteration, improper repair, or an act of God (such as a flood)

Installation was done by a trained, licensed or otherwise qualified HVAC dealer/contractor

- Performance has not been impaired by use of any product not authorized by Comfort-Aire/Century, or by any adjustments or adaptations to components
- Serial numbers and/or rating plate have not been altered or removed
- Damage has not been a result of inadequate wiring or voltage conditions, use during brown-out conditions, or circuit interruptions
- Air flow around the unit has not been restricted
- Unit remains in the original residential installation
- Any extended warranty is valid to original purchaser only (non-transferable)
- Owner must supply proof of proper maintenance over the life of the unit
- Unit was not purchased over the internet

DURATION OF WARRANTY & REGISTRATION

The warranty begins on the date of purchase by the original consumer. The original consumer must register at www.heatcontroller.com within 60 days of purchase. **The original consumer must retain a receipted bill of sale as proof of warranty period. To receive the AHRI-matched system warranty, also retain proof of the AHRI-matched system installation (part numbers, serial numbers, purchase and installation dates).** Without this proof, the warranty begins on date of shipment from the factory and reverts to the Six-Year Limited Express Parts Warranty.

REMEDY PROVIDED BY THE LIMITED EXPRESS WARRANTY

The sole remedy under the Limited Warranty is replacement of the defective part. If replacement parts are required within the period of this warranty, Comfort-Aire/Century replacement parts shall be used; any warranty on the replacement part(s) shall not affect the applicable original unit warranty. Labor to diagnose and replace the defective part is not covered by this Limited Express Warranty. Access to the unit for service is the owner's responsibility. If for any reason the replacement part/product is no longer available during the warranty period, Comfort-Aire/Century shall have the right to allow a credit in the amount of the current suggested retail price of the part/product instead of providing repair or replacement.

LIMITATION OF LIABILITY

1. **EXCLUSION OF ALL IMPLIED WARRANTIES AND LIMITATION.**

There are no other express or implied warranties. Comfort-Aire/Century makes no warranty of merchantability. We do not warrant that the unit is suitable for any particular purpose or can be used in buildings or rooms of any particular size or condition except as specifically provided in this document. There are no other warranties, express or implied, which extend beyond the description in this document.

2. All warranties implied by law are limited in duration to the six-year term of the non-AHRI matched system Parts Warranty. Your exclusive remedy is limited to the replacement of defective parts. **We will not be liable for any consequential or incidental damages caused by any defect in this unit.**
3. This warranty gives you specific legal rights and you may also have other rights which vary from state to state. Some states do not allow limitation on how long an implied warranty lasts or do not allow the exclusion or limitation of incidental or consequential damages, so the above limitations or exclusions may not apply to you.
4. No warranties are made for units sold outside the continental United States and Canada. Your distributor or final seller may provide a warranty on units sold outside these areas.
5. Comfort-Aire/Century will not be liable for damages if our performance regarding warranty resolution is delayed by events beyond our control including accident, alteration, abuse, war, government restrictions, strikes, fire, flood, or other acts of God.

COMMERCIAL INSTALLATION LIMITED EXPRESS WARRANTY

When installed in a commercial application, all parts and compressors are warranted to be free from defects in material and workmanship for ONE YEAR from the date of purchase by the original consumer for the original installation.

Please follow the below steps to register your product.

- **Please log onto our website www.heatcontroller.com.com**
- **Resources**
- **Product Registration**
- **Complete the requested information in all caps Especially the Email Address**
- **Press the "Continue" button at the bottom**
- **A copy of the registration will be sent to the email address that you entered at the top of the page for your records**

KEEP THIS INFORMATION AS A RECORD OF YOUR PURCHASE

Apply Serial Number and Model Number sticker here (from product carton). If unavailable, write serial number and model number below (can be found on unit rating plate).

Date of Purchase

Date Installation Completed

Component of new HVAC system Replacement furnace only

Remember to retain your bill of sale as proof of warranty period and ownership.



Please visit www.heatcontroller.com to register your new product

Due to ongoing product improvements, specifications and dimensions are subject to change and correction without notice or incurring obligations. Determining the application and suitability for use of any product is the responsibility of the installer. Additionally, the installer is responsible for verifying dimensional data on the actual product prior to beginning any installation preparations.

Incentive and rebate programs have precise requirements as to product performance and certification. All products meet applicable regulations in effect on date of manufacture; however, certifications are not necessarily granted for the life of a product. Therefore, it is the responsibility of the applicant to determine whether a specific model qualifies for these incentive/rebate programs.



1900 Wellworth Avenue • Jackson, MI 49203 • 517-787-2100

THIS PAGE WAS INTENTIONALLY LEFT BLANK

THIS PAGE WAS INTENTIONALLY LEFT BLANK

THIS PAGE WAS INTENTIONALLY LEFT BLANK